

40<sup>th</sup>  
anniversary

 floorwise

**Fantastic floors**  
start with **floorwise**

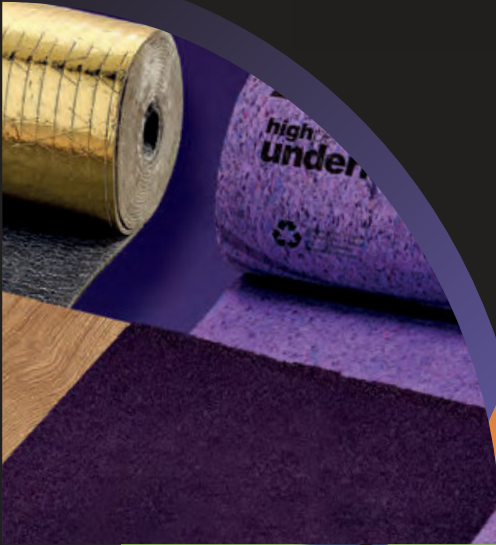

- UNDERLAY**
- ADHESIVES & SCREEDS**
- PROFILES**
- GRIPPER**
- TOOLS**
- TAPES**
- NOSINGS & TRIMS**
- MATTING**
- ARTIFICIAL GRASS**



# Fantastic Floors start with Floorwise

For over 40-years Floorwise has supplied the flooring industry with an ever wider range of products earning an enviable reputation along the way as the professionals choice. This range today includes underlay, gripper, adhesives and screeds, profiles, tools and far more – in fact everything you need to create a fantastic floor.

Floorwise products are renowned for combining quality and value and are available exclusively through our network of independent distributors who can help advise customers as the best option for their requirements with their extensive product knowledge.

This is why fantastic floors start with Floorwise.



This is a Floorwise product guide only. If you have any questions about prices please contact your local Floorwise distributor (see back cover).

## Underlays

Feel The Difference	8
PU Foam Underlays	10
Rubber and Felt Underlays	14
Carpet Underlay Selector	15
Wood/Laminate underlays	20
Plywood, Hardboard and Felt	24
Scotia	25

## Adhesives and screeds

Levelling and Smoothing compounds	26
Flooring and Cartridge Adhesives	28
Spray Adhesives	30

## Gripper

Premium Gripper	32
Diamond Gripper	32

## Profiles

Max Reflections	35
Max Profiles	36
Profile Displays	37
Classic Profiles	38
Zenith Profiles	40
Flexible PVC Floor Profiles	42

## Stair nosings

Aluminium Stair Nosings	45
Q Range	46
Stair Edge Trims and Angles	48
Floormitre Cap & Cove System	48
Flexible Bevels, Ramps, Profiles and Joints	49
PVC Skirtings	50
Colour Charts	52

## Tools and sundries

Cutting	55
Carpet Fitting	56
Measuring and Scribing	59
Surface Preparation	60
Wood and Laminate Floor Laying	62
PVC/Lino Laying	63
Workwear and Protection	64
Storage and Handling	64

## Entrance matting

Endurance, Fortitude and Manhattan	66
------------------------------------	----

## Tapes

Heatseam Tape	68
Adhesive Tape	69

## Artificial grass

Artificial Grass	70
Accessories	71

# Fantastic floors started with **floorwise** in

## 1982 - AN ICONIC YEAR

If you went to the cinema, you'd have most likely seen 'ET – the Extra Terrestrial', a relatively low budget new film by Steven Spielberg which went on to become one of the highest grossing movies of all time - even surpassing Star Wars.

In the intermission, there were some classic adverts with brilliant straplines like 'Possibly the best lager in the World'. Better still, whilst you were watching the film, you wouldn't have been irritated by the constant interruption and screen light from mobile phones - a new technology still in its infancy.

# 1982

Against this backdrop, The Floorwise Group Ltd. was incorporated in 1982 by a group of independent flooring wholesalers seeking to improve their buying power and to provide trade customers with better quality and value across a range of flooring installation products and accessories.

Over the last 40 years, Floorwise - like mobile phone technology - has constantly moved with the times, improving exponentially and building an ever-wider catalogue of award-winning flooring products. This includes now legendary products like Diamond Gripper and F599 Spray Adhesive alongside innovative new ones like our new Dichloromethane-Free F597 Spray Adhesive.

Today, Floorwise has become the trusted source for installers covering everything from underlays, gripper and profiles, to adhesives, screeds, tapes and a world-class collection of tools from leading brands.

With its distribution depots providing the exceptional quality and value of Floorwise products with the benefits of independent, local service, for many installers it's an unbeatable combination.

**So an awful lot has changed over the past 40 years - but if you still want great products and prices from friendly local experts, contact your local Floorwise distributor today and find out why Fantastic floors start with Floorwise.**



**Probably the best underlay in the world.**

Since 1982, we've been supplying some of the best underlays in the world (probably) from our own specifications. From our first ever roll of SXX on the floor to our F597 underlay, right down to the most advanced F597 underlay, Floorwise underlays have been at the heart of Fantastic Floors for 40 years - and that's something to be proud of.

Today, Floorwise continues to supply some of the best underlays in the world (probably) from our own specifications for use with carpet, wood, laminate, luxury vinyl tile and more. The underlay is made from a range of materials and is available in a variety of thicknesses and widths. Floorwise underlays have been at the heart of Fantastic Floors for 40 years - and that's something to be proud of.

40<sup>th</sup> anniversary 



**Great ideas tend to stick around.**

Since 1982, we've been supplying the flooring industry with products and services that have stood the test of time. Originally created for a group of independent wholesalers, we've grown into a major business, serving a wide range of customers with great quality and value.

From its humble beginnings, Floorwise has grown into one of the industry's most respected flooring installation and accessories brands, with a network of 25 distribution depots throughout the UK and Ireland. Floorwise has been at the heart of Fantastic Floors for 40 years - and that's something to be proud of.

40<sup>th</sup> anniversary 



# Underlay

<b>Carpet Underlays</b>	<b>6</b>
<b>Feel the Difference</b>	<b>8</b>
<b>PU Foam Underlays</b>	<b>10</b>
<b>Carpet Underlay Selector</b>	<b>16</b>

There are a wide range of underlay options available today; each has its own strengths and weaknesses so care should be taken in selecting the most suitable for your project.



## PU Foam Underlays The market leader!

Although light in weight, PU foam underlays pack a real punch when it comes to comfort and performance. Being under half the weight of traditional rubber underlays means that they can easily be handled on site in line with current health and safety regulations.

They are made from recycled post-industrial foam which is compressed and re-bonded to create a wide range of thicknesses and densities to suit a variety of applications and budgets.

The use of recycled materials helps to keep costs to a minimum making foam underlays excellent value for money and once they have reached the end of their useful life they are also 100% recyclable making them kinder to the environment – all of which explains their enduring popularity.

## Bouncebackability Index

Underlays are a great way to increase the comfort and durability of your flooring - but every underlay material has its own strengths and weaknesses to consider. This is where understanding bouncebackability can help decide what is best for you.

Bouncebackability considers the impact of density on an underlay as an Ultra High Density underlay will typically have over twice the weight of foam as a Medium Density underlay, compressed into the same volume. This increased density gives greater resistance to compression making it feel firmer underfoot. The higher foam densities are therefore ideal for use in more heavily trafficked areas such as halls, lounges and landings, and commercial applications. In contrast, lower density foams are great for lower trafficked areas where you may be barefoot and appreciate a softer feel, such as bedrooms.

The balance of comfort and durability greatly depends upon the flooring type, the place it is to be laid and the footfall expected. Our bouncebackability chart helps to explain how a higher density underlay will initially feel much firmer underfoot but will be more consistent as it better resists the longer-term compression forces generated through footfall. In contrast a lower density underlay will initially feel softer but this will decrease more rapidly as the foam compresses underfoot.

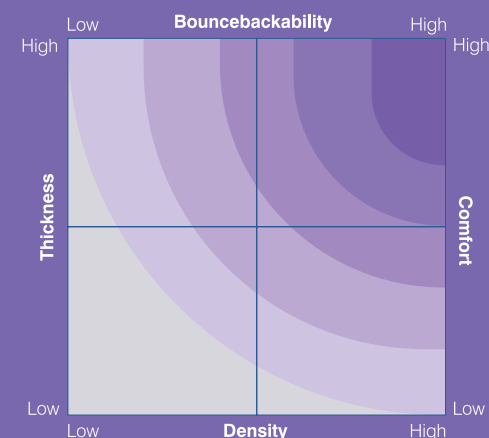

## Blown Rubber

Formed under intense heat to create pockets of air, this type of rubber underlay delivers increasingly higher levels of comfort and durability depending upon thickness and density.

## Crumb Rubber

Crumb rubber underlays are made using the rubber from recycled car tyres. They have the best durability and recovery ratings of all underlays. Suitable for areas of heavy wear in both residential and commercial installations, for many, these are the ultimate performance underlays, providing the best support for your carpet.

## Rubber Underlays

These more traditional underlays deliver an excellent balance of comfort and durability whilst their exceptional density provides excellent acoustic insulation properties.

## Wool Felt Underlays

As one of the original carpet underlays, wool felt continues to be the natural choice for your carpet. With exceptional heat insulation properties, wool felt underlays have great bedding down qualities and are extensively used with woven backed carpets. Made from recycled wool, jute and synthetic fibres these underlays are fully recyclable after their long use.

## Combination Crumb Rubber/Wool Felt Underlays

These combination underlays provide the exceptional recovery properties of crumb rubber, with the great bedding in and heat insulation properties of wool felt.

## Underlay Density

The denser the underlay, the more durable it is and the better it will perform over time. We offer 6 density categories as follows.



## Comfort

Comfort underfoot is primarily influenced by underlay thickness (although density also plays a part), with the thickest being the most comfortable. We offer underlays in a range of thicknesses.

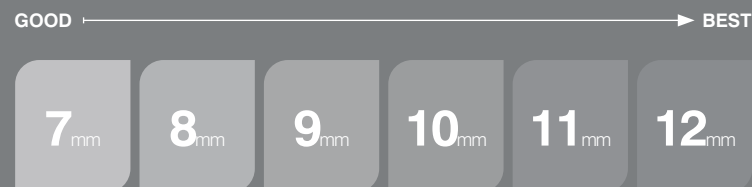

Using premium materials for underlays of exquisite quality. Feel the Difference is a collection that truly delivers comfort and luxury under your feet.



**UHC+**

## Elegance

10mm



### DESCRIPTION

High performance recycled PU foam underlay

**Roll size** 1.37 x 11m  
= 15.07m<sup>2</sup>

### APPLICATION

**Usage BS 5808** Luxury (L/U)

**Traffic** Residential or commercial

### PERFORMANCE

**Comfort** ★★★★★  
**Durability** ★★★★★★  
**Bounceback** ★★★★★  
**Heat Insulation** 2.68 TOG  
**Sound reduction** 41dB

## Inspiration

10mm



### DIMENSIONS

High performance sponge rubber waffle underlay

**Roll size** 1.37 x 8m  
= 10.96m<sup>2</sup>

### APPLICATION

**Usage BS 5808** Luxury (L/U)

**Traffic** Residential or commercial

### PERFORMANCE

**Comfort** ★★★★★  
**Durability** ★★★★★★  
**Bounceback** ★★★★★  
**Heat Insulation** 1.60 TOG  
**Sound reduction** 43dB

## Prestige

11mm



### DIMENSIONS

High performance rubber crumb plus felt underlay

**Roll size** 1.37 x 7.3m  
= 10.00m<sup>2</sup>

### APPLICATION

**Usage BS 5808** Heavy contract (HC/U)

**Traffic** Residential or commercial

### PERFORMANCE

**Comfort** ★★★★★  
**Durability** ★★★★★★  
**Bounceback** ★★★★★  
**Heat Insulation** 2.95 TOG  
**Sound reduction** 35dB

**SH+**

## Desire

9mm

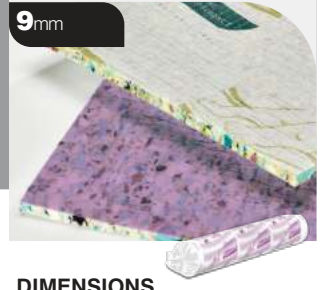

### DIMENSIONS

High performance recycled PU foam underlay

**Roll size** 11 x 1.37m  
= 15.07m<sup>2</sup>

### APPLICATION

**Usage BS 5808** Luxury (L/U)

**Traffic** Residential or commercial

### PERFORMANCE

**Comfort** ★★★  
**Durability** ★★★★★★  
**Bounceback** ★★★★★  
**Heat Insulation** 2.37 TOG  
**Sound reduction** 39dB

For prices contact your nearest distributor – see back cover

# PU Foam Underlays

**UHD+**

## Tread



**DIMENSIONS**  
**Roll size** 1.37 x 11m  
 = 15.07m<sup>2</sup>

**APPLICATION**  
**Usage BS 5808** Luxury (L/U)  
**Traffic** Residential or commercial

**PERFORMANCE**  
**Comfort** ★★★  
**Durability** ★★★★★  
**Bounceback** ★★★★★  
**Heat Insulation** 2.44 TOG  
**Sound reduction** 39dB

Mesh grid backing

**SHD+**

## Lift



**DIMENSIONS**  
**Roll size** 1.37 x 11m  
 = 15.07m<sup>2</sup>

**APPLICATION**  
**Usage BS 5808** Heavy contract (HC/U)  
**Traffic** Residential or commercial

**PERFORMANCE**  
**Comfort** ★  
**Durability** ★★★★★  
**Bounceback** ★★★★★  
**Heat Insulation** 2.02 TOG  
**Sound reduction** 39dB

Suitable for wheeled traffic



**DIMENSIONS**  
**Roll size** 1.37 x 11m  
 = 15.07m<sup>2</sup>

**APPLICATION**  
**Usage BS 5808** Luxury (L/U)  
**Traffic** Residential or commercial

**PERFORMANCE**  
**Comfort** ★★★★★  
**Durability** ★★★★★  
**Bounceback** ★★★★★  
**Heat Insulation** 2.89 TOG  
**Sound reduction** 43dB

**EHD+**

## Verve

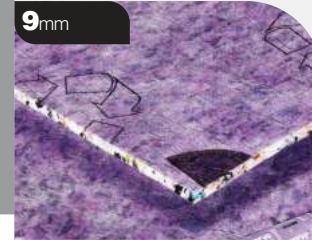

**DIMENSIONS**  
**Roll size** 1.37 x 11m  
 = 15.07m<sup>2</sup>

**APPLICATION**  
**Usage BS 5808** Luxury (L/U)  
**Traffic** Residential or commercial

**PERFORMANCE**  
**Comfort** ★★★  
**Durability** ★★★★★  
**Bounceback** ★★★★★  
**Heat Insulation** 2.54 TOG  
**Sound reduction** 40dB

## Maxi

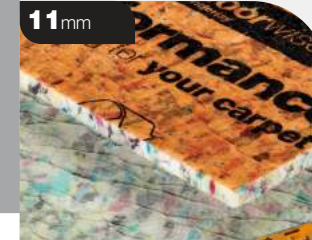

**DIMENSIONS**  
**Roll size** 1.37 x 11m  
 = 15.07m<sup>2</sup>

**APPLICATION**  
**Usage BS 5808** Luxury (L/U)  
**Traffic** Residential or commercial

**PERFORMANCE**  
**Comfort** ★★★★★  
**Durability** ★★★★★  
**Bounceback** ★★★  
**Heat Insulation** 3.50 TOG  
**Sound reduction** 45dB

## Traffic



**DIMENSIONS**  
**Roll size** 1.37 x 11m  
 = 15.07m<sup>2</sup>

**APPLICATION**  
**Usage BS 5808** Luxury (L/U)  
**Traffic** Residential

**PERFORMANCE**  
**Comfort** ★★★★★  
**Durability** ★★★★★  
**Bounceback** ★★★★★  
**Heat Insulation** 2.80 TOG  
**Sound reduction** 41dB

For prices contact your nearest distributor – see back cover

For prices contact your nearest distributor – see back cover



# PU Foam Underlays

HB+

## Panache

10mm

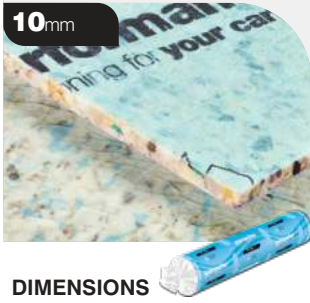

**DIMENSIONS**  
**Roll size** 1.37 x 11m  
 = 15.07m<sup>2</sup>

**APPLICATION**  
**Usage BS 5808** Luxury (L/U)  
**Traffic** Residential

**PERFORMANCE**  
**Comfort** ★★★★★  
**Durability** ★★★  
**Bounceback** ★★  
**Heat Insulation** 2.64 TOG  
**Sound reduction** 39dB

## Lusso

10mm

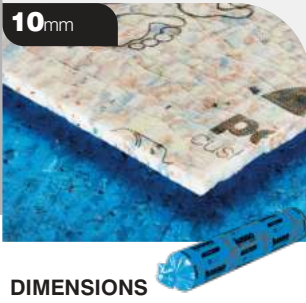

**DIMENSIONS**  
**Roll size** 1.37 x 11m  
 = 15.07m<sup>2</sup>

**APPLICATION**  
**Usage BS 5808** Luxury (L/U)  
**Traffic** Residential

**PERFORMANCE**  
**Comfort** ★★★★★  
**Durability** ★★★  
**Bounceback** ★★  
**Heat Insulation** 2.51 TOG  
**Sound reduction** 38dB

## Style

8mm

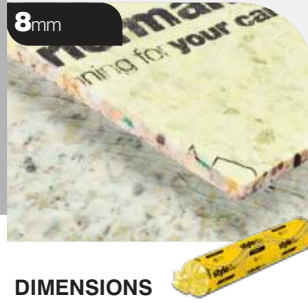

**DIMENSIONS**  
**Roll size** 1.37 x 11m  
 = 15.07m<sup>2</sup>

**APPLICATION**  
**Usage BS 5808** Luxury (L/U)  
**Traffic** Residential

**PERFORMANCE**  
**Comfort** ★★★  
**Durability** ★★★  
**Bounceback** ★★★  
**Heat Insulation** 2.18 TOG  
**Sound reduction** 32dB

## Prima

8mm

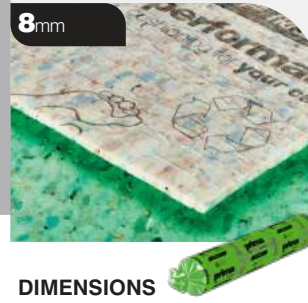

**DIMENSIONS**  
**Roll size** 1.37 x 11m  
 = 15.07m<sup>2</sup>

**APPLICATION**  
**Usage BS 5808** Luxury (L/U)  
**Traffic** Residential

**PERFORMANCE**  
**Comfort** ★★★  
**Durability** ★★★  
**Bounceback** ★★★  
**Heat Insulation** 1.96 TOG  
**Sound reduction** 33dB

MB+

## Essentials 10mm

10mm



**DIMENSIONS**  
**Roll size** 1.37 x 11m  
 = 15.07m<sup>2</sup>

**APPLICATION**  
**Usage BS 5808** General (GD/U)  
**Traffic** Residential

**PERFORMANCE**  
**Comfort** ★★★★★  
**Durability** ★★  
**Bounceback** ★  
**Heat Insulation** 2.40 TOG  
**Sound reduction** 38dB

## Essentials 8mm

8mm

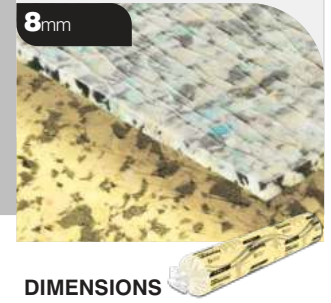

**DIMENSIONS**  
**Roll size** 1.37 x 11m  
 = 15.07m<sup>2</sup>

**APPLICATION**  
**Usage BS 5808** General (GD/U)  
**Traffic** Residential

**PERFORMANCE**  
**Comfort** ★★★  
**Durability** ★★  
**Bounceback** ★★  
**Heat Insulation** 1.90 TOG  
**Sound reduction** 33dB

For prices contact your nearest distributor – see back cover

For prices contact your nearest distributor – see back cover

# Rubber and Felt Underlays

**UHD+**

## Pinnacle

10mm



**DIMENSIONS**

**Roll size** 1.37 x 8m  
= 10.96m<sup>2</sup>

**APPLICATION**

**Usage BS 5808** Luxury (L/U)  
**Traffic** Residential or commercial

**PERFORMANCE**

**Comfort** ★★★★★  
**Durability** ★★★★★  
**Bounceback** ★★★★★  
**Heat Insulation** 1.50 TOG  
**Sound reduction** 42dB

## Champion

8mm



**DIMENSIONS**

**Roll size** 1.37 x 8m  
= 10.96m<sup>2</sup>

**APPLICATION**

**Usage BS 5808** Heavy contract (HC/U)  
**Traffic** Residential or commercial

**PERFORMANCE**

**Comfort** ★★  
**Durability** ★★★★★★  
**Bounceback** ★★★★★★  
**Heat Insulation** 1.40 TOG  
**Sound reduction** 33dB

Suitable for wheeled traffic

## Vigour

6.75mm



**DIMENSIONS**

**Roll size** 1.37 x 11m  
= 15.07m<sup>2</sup>

**APPLICATION**

**Usage BS 5808** Heavy contract (HC/U)  
**Traffic** Residential or commercial

**PERFORMANCE**

**Comfort** ★  
**Durability** ★★★★★★  
**Bounceback** ★★★★★★  
**Heat Insulation** 1.20 TOG  
**Sound reduction** 31dB

Suitable for wheeled traffic

**UHD+**

## Duet Sovereign

11mm



**DIMENSIONS**

**Roll size** 1.37 x 8m  
= 10.00m<sup>2</sup>

**APPLICATION**

**Usage BS 5808** Heavy contract (HC/U)  
**Traffic** Residential or commercial

**PERFORMANCE**

**Comfort** ★★★★★  
**Durability** ★★★★★★  
**Bounceback** ★★★★★★  
**Heat Insulation** 2.95 TOG  
**Sound reduction** 34dB

**SH+**

## Thermaflow Impact

6.75mm



**DIMENSIONS**

**Roll size** 1.37 x 8m  
= 10.96m<sup>2</sup>

**APPLICATION**

**Usage BS 5808** Heavy contract (HC/U)  
**Traffic** Residential or commercial

**PERFORMANCE**

**Comfort** ★★  
**Durability** ★★★★★  
**Bounceback** ★  
**Heat Insulation** 0.79 TOG  
**Sound reduction** 31dB

Suitable for wheeled traffic

**HG+**

## Symphony

11mm



**DIMENSIONS**

**Roll size** 1.37 x 11m  
= 15.07m<sup>2</sup>

**APPLICATION**

**Usage BS 5808** Heavy contract (HC/U)  
**Traffic** Residential or commercial

**PERFORMANCE**

**Comfort** ★★★  
**Durability** ★★★★★★  
**Bounceback** ★★★★★★  
**Heat Insulation** 2.50 TOG  
**Sound reduction** 32dB

\* A range of thicknesses are available. See pages 18 and 19

For prices contact your nearest distributor – see back cover

For prices contact your nearest distributor – see back cover



# Carpet Underlay Selector

**Key** ✓✓ Recommended ✓ Suitable ✓\* Stretch Fit installations only

Each Floorwise underlay has unique performance characteristics. We have included a recommendation table for you to be able to easily compare the underlays. Please note that generally the thicker the underlay, the better the underfoot comfort, whilst the greater the density the better the underlay will perform over time.

The table includes a classification column, which rates the underlay to BS EN 14499 standards. Also included in the table are TOG ratings, with some underlays being better insulators than others. Finally, there is an impact sound rating, which is a guide to how well the underlay suppresses noise from the room above.

Range	Product	Use					Performance				Specification				
		GB	MB	L/DR	H,S,L	Comm	Comfort	Durability	Bounceback	Thickness (mm)	Dimensions w x l = m <sup>2</sup>	EN use BS5808	Roll weight (kg)	Heat insulation (TOG)	Sound reduction (dB)
<b>Ultra High Density</b> 	Elegance	✓✓	✓✓	✓✓	✓	✓*	****	*****	*****	10	1.37 x 11.0 = 15.07	L/U	24.8	2.68	31
	Inspiration	✓✓	✓✓	✓✓	✓	✓*	****	*****	****	10	1.37 x 8.0 = 10.96	L/U	40.5	1.60	43
	Prestige	✓✓	✓✓	✓✓	✓	✓*	****	*****	*****	11	1.37 x 7.3 = 10.00	L/U	36.0	2.95	35
	Desire	✓✓	✓✓	✓✓	✓	✓*	***	*****	*****	9	1.37 x 11.0 = 15.07	L/U	21.0	2.95	35
<b>Ultra High Density</b> 	Tread	✓✓	✓✓	✓✓	✓✓	✓	***	*****	*****	9	1.37 x 11.0 = 15.07	L/U	25.2	2.44	39
	Lift	✓✓	✓✓	✓✓	✓✓	✓✓	*	*****	*****	7	1.37 x 11.0 = 15.07	HC/U	19.8	2.02	39
<b>Super High Density</b> 	Supreme	✓✓	✓✓	✓✓	✓	✓*	****	*****	****	11	1.37 x 11.0 = 15.07	L/U	24.0	2.89	43
	Allure	✓✓	✓✓	✓✓	✓	✓*	****	*****	****	11	1.37 x 11.0 = 15.07	L/U	23.0	2.89	43
	Vitality	✓✓	✓✓	✓✓	✓✓	✓*	***	*****	*****	9	1.37 x 11.0 = 15.07	L/U	19.7	2.37	39
	Verve	✓✓	✓✓	✓✓	✓✓	✓*	***	*****	*****	9	1.37 x 11.0 = 15.07	L/U	19.5	2.54	40
<b>Extra High Density</b> 	Maxi	✓✓	✓✓	✓✓	✓	✓*	*****	****	***	11	1.37 x 11.0 = 15.07	L/U	21.0	3.50	45
	Flexilay 11	✓✓	✓✓	✓✓	✓✓	✓*	*****	****	***	11	1.37 x 11.0 = 15.07	L/U	21.0	3.55	39
	Esteem	✓✓	✓✓	✓✓	✓	✓*	****	****	***	10	1.37 x 11.0 = 15.07	L/U	21.0	3.55	39
	Traffic	✓✓	✓✓	✓✓	✓	✓*	****	****	****	9	1.37 x 11.0 = 15.07	L/U	17.4	2.80	41
	Flexilay 9	✓✓	✓✓	✓✓	✓	✓*	****	****	****	9	1.37 x 11.0 = 15.07	L/U	17.4	2.80	41
<b>High Density Plus</b> 	Lush	✓✓	✓✓	✓✓	✓	-	*****	***	**	12	1.37 x 11.0 = 15.07	L/U	19.2	3.26	45
	Panache	✓✓	✓✓	✓✓	✓	-	*****	***	**	10	1.37 x 11.0 = 15.07	L/U	15.8	2.64	39
	Spirit	✓✓	✓✓	✓✓	✓	-	****	***	**	10	1.37 x 11.0 = 15.07	L/U	16.0	2.83	36
	Lusso	✓✓	✓✓	✓✓	✓	-	*****	***	**	10	1.37 x 11.0 = 15.07	L/U	15.6	2.51	38
	Style	✓✓	✓✓	✓✓	✓	-	***	***	***	8	1.37 x 11.0 = 15.07	L/U	12.6	2.18	32
	Solo	✓✓	✓✓	✓✓	✓	-	***	***	***	8	1.37 x 11.0 = 15.07	L/U	12.8	2.48	34
	Prima	✓✓	✓✓	✓✓	✓	-	***	***	***	8	1.37 x 11.0 = 15.07	L/U	12.6	1.96	33

All products are recommended for use in GB - General Bedroom, MB - Master Bedroom, L/DR - Lounge/Dining Room, H/S/L Hall/Stairs/Landing, Comm - Commercial Use.

# Carpet Underlay Selector

Each Floorwise underlay has unique performance characteristics. We have included a recommendation table for you to be able to easily compare the underlays. Please note that generally the thicker the underlay, the better the underfoot comfort, whilst the greater the density the better the underlay will perform over time.

**Key** ✓✓ Recommended ✓ Suitable ✓\* Stretch Fit installations only

The table includes a classification column, which rates the underlay to BS EN 14499 standards. Also included in the table are TOG ratings, with some underlays being better insulators than others. Finally, there is an impact sound rating, which is a guide to how well the underlay suppresses noise from the room above.

Range	Product	Use								Performance						Specification			
		GB	MB	L/DR	H,S,L	Comm	Comfort	Durability	Bounceback	Thickness (mm)	Dimensions w x l = m <sup>2</sup>	EN use BS5808	Roll weight (kg)	Heat insulation (TOG)	Sound reduction (dB)				
PU foam	<b>Medium Density</b> <b>MD+</b>	Fascino	✓✓	✓✓	✓✓	✓	-	*****	**	**	12	1.37 x 11.0 = 15.07	GD/U	15.3	2.80	45			
	Essentials 10mm	✓✓	✓	✓✓	✓	-	*****	**	**	10	1.37 x 11.0 = 15.07	GD/U	12.9	2.40	38				
	Attivo	✓✓	✓	✓✓	✓	-	*****	**	**	10	1.37 x 11.0 = 15.07	GD/U	12.9	2.45	38				
	Essentials 8mm	✓✓	✓	✓✓	✓	-	***	**	**	8	1.37 x 11.0 = 15.07	GD/U	10.5	1.90	33				
	Senso	✓✓	✓	✓✓	✓	-	**	**	**	8	1.37 x 11.0 = 15.07	GD/U	10.5	1.95	33				
Rubber	<b>Ultra High Density</b> <b>UHD+</b>	Champion	✓✓	✓✓	✓✓	✓✓	✓	**	*****	*****	8	1.37 x 8.0 = 10.96	HC/U	34.0	1.40	33			
	Vigour	✓✓	✓✓	✓✓	✓✓	✓✓	*	*****	*****	6.75	1.37 x 11.0 = 15.07	HC/U	36.5	1.20	31				
	Pinnacle	✓✓	✓✓	✓✓	✓	✓*	****	*****	****	10	1.33 x 8.24 = 10.96	L/U	40.5	1.50	42				
	<b>Super High Density</b> <b>SH+</b>	Thermaflow Impact	✓✓	✓✓	✓✓	✓✓	✓*	*	*****	*****	6.75	1.33 x 8.24 = 10.96	HC/U	39.0	0.79	31			
Crumb rubber/Wool felt	<b>Ultra High Density</b> <b>UHD+</b>	Duet Sovereign 10m <sup>2</sup>	✓✓	✓✓	✓✓	✓	✓*	****	*****	*****	11	1.37 x 11.0 = 15.07	HC/U	24.0	2.95	33			
	Duet Sovereign 15.07m <sup>2</sup>	✓✓	✓✓	✓✓	✓	✓*	****	*****	*****	11	1.37 x 7.3 = 10.00	HC/U	36.2	2.95	34				
	Duet Supreme 10m <sup>2</sup>	✓✓	✓✓	✓✓	✓	✓*	****	*****	*****	10	1.37 x 11.0 = 15.07	HC/U	24.0	2.90	34				
	Duet Supreme 15.07m <sup>2</sup>	✓✓	✓✓	✓✓	✓	✓*	****	*****	*****	10	1.37 x 7.3 = 10.00	HC/U	36.2	2.90	34				
	Duet 10m <sup>2</sup>	✓✓	✓✓	✓✓	✓	✓*	***	*****	*****	9	1.37 x 11.0 = 15.07	HC/U	20.0	2.70	32				
	Duet 15.07m <sup>2</sup>	✓✓	✓✓	✓✓	✓	✓*	***	*****	*****	9	1.37 x 7.3 = 10.00	HC/U	30.2	2.70	32				
Wool felt	<b>High Density</b> <b>HD+</b>	Symphony 56	✓✓	✓✓	✓✓	✓	✓*	****	****	**	13.75	1.37 x 11.0 = 15.07	HC/U	28.6	2.90	38			
	Symphony 52	✓✓	✓✓	✓✓	✓✓	✓*	****	****	**	13	1.37 x 11.0 = 15.07	HC/U	25.2	2.80	35				
	Symphony 42	✓✓	✓✓	✓✓	✓✓	✓*	***	****	***	11	1.37 x 11.0 = 15.07	HC/U	21.5	2.50	32				
	Symphony 28	✓✓	✓	✓✓	✓	✓*	*	****	***	8	1.37 x 11.0 = 15.07	GD/U	14.3	-	-				

All products are recommended for use in GB - General Bedroom, MB - Master Bedroom, L/DR - Lounge/Dining Room, H/S/L Hall/Stairs/Landing, Comm - Commercial Use.

# Wood, Laminate and LVT Underlays

<b>Acoustica Gold Excel</b>	<b>21</b>
<b>Acoustica Silver</b>	<b>21</b>
<b>Acoustica Fibreboard</b>	<b>21</b>
<b>Wood, Laminate and LVT Selector</b>	<b>22</b>

Floorwise brings together a wide range of different types of non-carpet underlays.



Floorwise brings together a wide range of different types of specialist underlay for use under Wood, Laminate and LVT flooring. These underlays are thinner than those used under carpets and are ideal for helping to provide cushioned support and absorbing minor surface imperfections making for an easy installation that will prolong the life of your floorcovering. Equally importantly they will significantly reduce the sound made by wood, laminate & LVT floorcoverings making for a nicer living environment.

The Floorwise acoustica range of dense rubber underlays are excellent at absorbing noise, both between floors by way of impact sound reduction and within the room through airborne noise reduction.

The whisper range of PE foam underlays are also very good at absorbing impact noise but do not perform to the same standards as the acoustica range for airborne sound. The Floorwise range of wood, Laminate and LVT Underlays is all rated according to our Sound Reduction guide to help decide which product will be best for your project.

<b>USR+</b>	<b>PSR+</b>	<b>ESR+</b>	<b>GSR+</b>	<b>BSR</b>
<b>Ultimate Sound Reduction</b>	<b>Premium Sound Reduction</b>	<b>Enhanced Sound Reduction</b>	<b>Good Sound Reduction</b>	<b>Basic Sound Reduction</b>

## Acoustica Underlays

<p><b>USR+</b></p> <p><b>Acoustica Gold Excel</b></p> <p><b>3mm</b></p>  <p><b>DIMENSIONS</b> Roll size 1 x 10m = 10m<sup>2</sup></p> <p><b>Thickness</b> 3.00mm <b>Density</b> 930 kg/m<sup>3</sup></p> <p><b>APPLICATION</b> <b>Airborne sound</b> Excellent <b>Impact sound</b> 23dB <b>TOG</b> 0.25</p> <p>- Built in water vapour barrier - Absorbs minor floor imperfections</p>	<p><b>ESR+</b></p> <p><b>Acoustica Silver</b></p> <p><b>2mm</b></p>  <p><b>DIMENSIONS</b> Roll size 1 x 10m = 10m<sup>2</sup></p> <p><b>Thickness</b> 2.0mm <b>Density</b> 925 kg/m<sup>3</sup></p> <p><b>APPLICATION</b> <b>Airborne sound</b> Great <b>Impact sound</b> 22dB <b>TOG</b> 0.22</p> <p>- Built in water vapour barrier - Absorbs minor floor imperfections</p>	<p><b>GSR+</b></p> <p><b>Acoustica Fibreboard</b></p> <p><b>5mm</b></p>  <p><b>DIMENSIONS</b> <b>Panel size</b> 0.59x0.85m = 0.5m<sup>2</sup> x 20 = 10.03m<sup>2</sup></p> <p><b>Thickness</b> 5.0mm <b>Density</b> 250 kg/m<sup>3</sup></p> <p><b>APPLICATION</b> <b>Airborne sound</b> Good <b>Impact sound</b> 22dB <b>TOG</b> 0.50</p> <p>- Absorbs minor floor imperfections</p>
---	--	---

For prices contact your nearest distributor – see back cover



## Wood, Laminate and LVT Selector

Each Floorwise underlay has unique performance characteristics. We have included a recommendation table for you to be able to easily compare the underlays. Please note that generally the denser the underlay the better it is at reducing sound, which is why Rubber underlays are generally the best option for this application.

Range name	Application					Material	Specification			Specification				
	GB	MB	L/DR	H,S,L	Comm		Density kg/m <sup>3</sup>	Roll weight kg	Moisture barrier	Thickness (mm)	Dimensions w x l = m2	Sound performance class	TOG	Impact sound dB
Acoustica Platinum	✓✓	✓✓	✓✓	✓✓	✓✓	Supreme Rubber	707	38.4	✓	3.75	1.37 x 11.0 = 15.07	USR+	0.28	23
Acoustica Gold Supreme	✓✓	✓✓	✓✓	✓✓	✓✓	Rubber Crumb	350	12.3	✓	3.50	1.0 x 10.0 = 10.0	USR+	0.80	23
Acoustica Gold Excel	✓✓	✓✓	✓✓	✓✓	✓✓	Supreme Rubber	930	28.0	✓	3.00	1.0 x 10.0 = 10.0	USR+	0.28	23
Acoustica Gold	✓✓	✓✓	✓✓	✓✓	✓✓	Supreme Rubber	735	21.4	✓	3.00	0.685 x 14.0 = 10.0 or 1.37 x 7.3 = 10.0	PSR+	0.25	20
Acoustica Silver Supreme	✓✓	✓✓	✓✓	✓✓	✓✓	Rubber Crumb	350	10.5	✓	3.00	1.0 x 10.0 = 10.0	PSR+	0.70	22
Acoustica Bronze	✓✓	✓✓	✓✓	✓✓	✓✓	Premium Rubber	735	32.2	-	2.00	1.37 x 11 = 15.07	PSR+	0.22	22
Acoustica Silver	✓✓	✓✓	✓✓	✓✓	✓✓	Premium Rubber	925	18.5	✓	2.00	1 x 10.0 = 10.0	ESR+	0.22	22
Acoustica LVT 18dB	✓✓	✓✓	✓✓	✓✓	✓✓	Rubber	1666	25.0	-	1.50	1.37 x 7.0 = 10.0	ESR+	0.12	18
Acoustica Fibreboard	✓✓	✓✓	✓✓	✓✓	✓✓	Wood Fibre	-	-	-	5.00	0.59 x 0.85 = 10.03	GSR+	0.50	22
Whisper Gold	✓✓	✓✓	✓✓	✓✓	✓✓	PE Foam	30	1.78	✓ +overlap	5.00	1.0 x 10.0 = 10.0	PSR+	1.20	21
Whisper Guard	✓✓	✓✓	✓✓	✓✓	✓✓	PE Foam	65	2.92	✓ +overlap	3.50	1.0 x 10.0 = 10.0	PSR+	0.88	23
Whisper Silver*	✓✓	✓✓	✓✓	✓✓	-	PE Foam	30	1.77	✓ +overlap	3.00	1.0 x 15.0 = 15.0	GSR+	0.87	19
Whisper Green Barrier*	✓✓	✓✓	✓✓	✓✓	-	PE Foam	30	1.93	✓ +overlap	3.00	1.0 x 15.0 = 15.0	GSR+	0.72	19
Whisper 3mm*	✓✓	✓✓	✓✓	✓✓	-	PE Foam	20	0.90	-	3.00	1.0 x 15.0 = 15.0	BSR	0.71	18
Whisper 2mm*	✓✓	✓✓	✓✓	✓✓	-	PE Foam	20	0.60	-	2.00	1.0 x 15.0 = 15.0	BSR	0.41	18

All products are recommended for use in GB - General Bedroom, MB - Master Bedroom, L/DR - Lounge/Dining Room, H/S/L Hall/Stairs/Landing, Comm - Commercial Use.

## Plywood, Hardboard and Paper Felt

### SP101 Flooring Plywood

5.5mm



#### DESCRIPTION

SP101 Flooring Plywood® has been developed to exceed BS8203 standards as a fully reliable underlay meant for use in the sub-floor preparation in readiness for all types of floorcovering.

Available in a range of thicknesses and sizes.

#### BENEFITS

- ✓ Meets BS8203: 2017 – Plywood Annex A
- ✓ TFT Woodexperts Diamond Mark Certified
- ✓ High quality face veneers
- ✓ Reliable glue line performance
- ✓ Accurate dimensional tolerances
- ✓ Recommended by most flooring manufacturers

### Hardboard

3.2mm



#### DESCRIPTION

Our hardboard is a versatile general purpose fibreboard usually used for levelling uneven floorboards.

### Paper Felt



#### DESCRIPTION

Our quality lining paper helps protect the subfloor and prevents dust from rising through the floorboards. Available in a range of weights and roll sizes.

#### Weights

TBC: i.e 1m x 50m 175 gsm or 1m x 100m 175 gsm or 2m x 100m 150gsm

## Scotia

### F541 Scotia



#### DESCRIPTION

Wood foiled  
16.5mm x 16.5mm x 2.4m

Used to cover the expansion gap on wood and laminate floors.

Available in a wide range of decors, ask your local distributor for a set of colour samples.



For prices contact your nearest distributor – see back cover

# Adhesives and screeds

Levelling and Smoothing Compounds	27
Flooring and Cartridge Adhesives	28
Spray Adhesives	29

Floorwise supply the flooring professional with a versatile range of high-quality adhesives and levelling compounds which won't let you down on the job!

All contractors know that the perfect floor needs a perfect base and our range of screeds and levelling compounds cover every need in order to achieve this.

Next they require is an adhesive that holds fast and lasts the course – contractors who try Floorwise adhesives stick with them.

Floorwise won't let you down when it comes to product quality, availability or supply.



## F5GOLD Pro-Screed Gold

### Part rapid setting latex polymer levelling & smoothing compound

A versatile 2-part latex polymer levelling and smoothing compound with excellent flow and adhesion properties. The unique formulation qualities allow the compound to be installed without the need to prime on most sub floors including timber. It is moisture tolerant and can be laid under and over DPM's and can be applied over most underfloor heating systems.

<b>WALK ON TIME :</b>	90 Minutes
<b>WORKING TIME :</b>	Approximately 20 minutes
<b>APPLY FLOORCOVERING :</b>	Typically 4 hours (3 hours for ceramic tiles)
<b>COMPRESSIVE STRENGTH:</b>	C16 after 28 days
<b>APPLICATION THICKNESS:</b>	Featheredge to 10mm unfilled. From 10mm to 30mm filled with 3mm granite chippings
<b>COVERAGE</b>	5–6m <sup>2</sup> @ 3mm per 20kg bag + 5L liquid



## F599 Heavy Duty Spray Adhesive

### Spray adhesive

This market-leading Floorwise heavy duty spray adhesive can be used to fix a wide variety of floor coverings onto most sub floor types. This is thanks to F599 offering a higher percentage of solids than many other spray adhesives giving it a competitive advantage.

<b>COVERAGE :</b>	Approx. 3m <sup>2</sup> per can onto a single non-porous surface
-------------------	--



- Higher solids providing you more adhesive per can
- Higher coat weight giving you more surface adhesive
- Excellent bond strength
- Super quick drying

Not suitable for highly plasticised Vinyls or PVC







## Adhesive and Screeds

Product type	Product range	Product code	Coverage m <sup>2</sup>	Pack size
<b>Application</b>				
<b>Levelling and smoothing</b> 	Pro-Screed Gold 2 Part rapid setting latex polymer levelling & smoothing compound	<b>F5GOLD</b>	5–6m <sup>2</sup> @ 3mm per 20kg bag + 5l liquid	20kg bag
	Pro-Screed Gold Latex Liquid	<b>F5GOLDLL</b>		5l tub
	Pro-Screed Feather Edge ultra fine, rapid setting levelling & patch repair compound	<b>F5FEA</b>	45m <sup>2</sup> @ 1mm per 10kg bag mixed with 5l water	10kg bag
<b>Flooring adhesives</b> 	All Purpose Low VOC Flooring Adhesive	<b>F556</b>	Approx. 50-60m <sup>2</sup>	15kg tub
	All Purpose Water Based Flooring Adhesive	<b>F555</b>	Approx. 45–55m <sup>2</sup>	15kg tub
	Low VOC Acrylic Carpet Tile Tackifier	<b>F523</b>	140–160m <sup>2</sup>	15kg tub
			Approx. 230–250m <sup>2</sup>	25kg container
	MS (Modified Silicone) Polymer Wood Flooring Adhesive	<b>F542</b>	16-24m <sup>2</sup>	16kg bucket
Approx. 10 Linear metres of 8mm bead			600ml sausage	
<b>Cartridge adhesives and sealants</b> 	Silicone Joint Sealant	<b>F500</b>	Approx. 11 Linear metres of a 6mm bead	310 ml cartridge
	Fast Set Floor-Fix PU Adhesive	<b>F579</b>	Approx. 40 Linear metres of a 3mm bead	310 ml cartridge
	Floor Fix Mastic Adhesive	<b>F577</b>	Approx. 11 Linear metres of a 6mm bead	310 ml cartridge
	Flexy Fix MS Polymer Adhesive	<b>FLE290</b>	15 Linear metres of a 5mm bead	290 ml cartridge

For prices contact your nearest distributor – see back cover

For prices contact your nearest distributor – see back cover

## Adhesive and Screeds

Product type	Product range	Product code	Coverage m <sup>2</sup>	Pack size
<b>Application</b>				
<b>Spray adhesives</b>				
	Heavy Duty Spray Adhesive	<b>F599</b>	Approx. 3m <sup>2</sup> per can onto a single non-porous surface	500ml can
	DCM Free Heavy Duty Spray Adhesive	<b>F597</b>	Approx. 3m <sup>2</sup> per can onto a single non-porous surface	500ml can
	Contact Spray Adhesive	<b>F592</b>	Approx. 3m <sup>2</sup> per can onto a single non-porous surface	500ml can
	Solvent Cleaner	<b>F590</b>	-	500ml can
	Vinyl Spray Adhesive	<b>F595</b>	Approx. 3m <sup>2</sup> per can onto a single non-porous surface	500ml can
	Heavy Duty Spray Adhesive	<b>F596</b>	Approx. 3m <sup>2</sup> per can onto a single non-porous surface	500ml can
	Spray Adhesive	<b>F598</b>	Approx. 3m <sup>2</sup> per can onto a single non-porous surface	500ml can
<b>Cannister spray adhesives</b>				
	Contact Spray Adhesive	<b>F592C</b>	Approx. 100-150m <sup>2</sup> on a single sided application per 19.5L canister, dependent upon the porosity of the subfloor.	17kg
	Super Contact Spray Adhesive	<b>F593C</b>	Approx. 100-150m <sup>2</sup> on a single sided application per 19.5L canister, dependent upon the porosity of the subfloor.	17kg
	Carpet Tackifier Spray Adhesive	<b>F594C</b>	Approx. 300-500m <sup>2</sup> on a single sided application per 19.5L canister, dependent upon the weight of application and porosity of the subfloor.	13kg
<b>Cannister spray accessories</b>				
	Standard Gun for spray canisters	<b>F7252</b>	-	Spray gun head
	Premium Gun for spray canisters	<b>F7251</b>	-	Spray gun head
	Standard Gun & Wand for spray canisters	<b>F7253</b>	-	Spray gun head and wand
	12ft Hose for spray cannisters	<b>F7254/12</b>	-	1 hose
	18ft Hose for spray cannisters	<b>F7254/18</b>	-	1 hose

For prices contact your nearest distributor – see back cover

For prices contact your nearest distributor – see back cover

# Gripper

<b>Diamond Gripper</b>	<b>33</b>
<b>Premium Gripper</b>	<b>33</b>

Floorwise supplies a range gripper options to suit almost any installation.

## Diamond Gripper

Our Diamond Gripper range is both thicker at 6.3mm and wider at 25mm than most other grippers but it also has up to 20% more pins and nails than found on an entry level standard gripper. The pre-set fixing nails are designed for use with concrete, timber or mixed flooring substrates making it easier to install. Similarly the pins are zinc coated for added durability and have a choice of medium or long pins to suit differing carpet types providing greater long-term stability for the carpet thereby extending its service life.

We recommend using Diamond Gripper for commercial power stretching installations.

## Premium Gripper

The Floorwise Premium Gripper range is again thicker at 6.0mm and wider at 22mm with more pins and nails than you would find in a standard budget gripper. The pre-set fixing nails designed for use with concrete, timber or mixed flooring substrates make it easier to install whilst the increased pin count and option for short, medium or long pins to suit the individual carpet type offers greater long-term stability for the carpet.



## Gripper

Product		Specification	
Code	Product name	Pins/nails	Nail length (mm)
<b>TIMBER FLOORS</b>			
<b>F160</b>	Diamond Gripper Pre-nailed, Medium Pin	78/12	25
<b>F150</b>	Premium Gripper, Pre-nailed, Medium Pin	69/10	17.5
<b>CONCRETE FLOORS</b>			
<b>F161</b>	Diamond Gripper Pre-nailed, Medium Pin	78/12	25
<b>F151</b>	Premium Gripper, Pre-nailed, Medium Pin	69/10	17.5
<b>DUAL PURPOSE (TIMBER/CONCRETE)</b>			
<b>F167</b>	Diamond Gripper, Pre-nailed, Medium Pin	78/12	25
<b>F162</b>	Premium Gripper, Pre-nailed, Medium Pin	69/10	17.5
<b>STICK DOWN</b>			
<b>F152</b>	Stick Down Gripper, Medium Pin	-	-



For prices contact your nearest distributor – see back cover



# Profiles

<b>Max Reflections</b>	<b>35</b>
<b>Max</b>	<b>36</b>
<b>Classic</b>	<b>38</b>
<b>Zenith</b>	<b>40</b>
<b>Flexible PVC</b>	<b>42</b>

Providing that finishing touch for all types of floor coverings.

Floorwise profiles are made to the highest standards. Crafted from premium quality metals, our profiles are easy to handle and deliver longer lasting use.

Wrapped in protective film to keep damage and unsightly scratches at bay, Floorwise profiles are packed to arrive in perfect condition.

## max Reflections profile range

Give your room the ultimate makeover and co-ordinate with metallic fixtures and fittings using Max Reflections.

## the max profile range

Where strength and rigidity are a must, make sure it's the Max.

## the Classic profile range

A precision blend of performance and value, the Classic Profile Range includes some of the best selling profiles for carpet and vinyl floorcoverings.

## the Zenith profile range

A precision blend of performance and value, the Classic Profile Range includes some of the best selling profiles for carpet and vinyl floorcoverings.

## FlexiblePVC floor profiles

A range of quality PVC profiles in a variety of colours that can be laid straight or easily curved on site.



## max Reflections

Give your room the ultimate makeover with **Max Reflections** from Floorwise. Coordinate with other metallic fixtures and fittings.

**Packing** - Box: 0.9m lengths x 15 = 13.5m Tube: 2.7m lengths x 5 = 13.5m

Product	Dimensions	Finish	Length (m)	Tube qty	Ref.
<b>217</b> Single Edge (Carpet Edging Strip)		Chrome	0.9	15	217.3C
		Brushed Steel	2.7	5	217.9C
		Nickel	0.9	15	217.3BSN
<b>235</b> Dual edge (carpet to carpet)		Chrome	0.9	15	235.3C
		Brushed Steel	2.7	5	235.9C
		Nickel	0.9	15	235.3BSN
<b>248</b> Z Edge - adjustable up to 9mm (carpet to wood/ laminate/ceramics)		Chrome	0.9	15	248.3C
		Brushed Steel	2.7	5	248.9C
		Nickel	0.9	15	248.3BSN
<b>251</b> 2-in-1 Stick Down Ramp Edge/Cover Strip 0-6mm		Chrome	0.9	15	251.3C
		Brushed Steel	2.7	5	251.9C
		Nickel	0.9	15	251.3BSN
<b>252</b> Stick Down Cover Strip 38mm (universal)		Chrome	0.9	15	252.3C
		Brushed Steel	2.7	5	252.9C
		Nickel	0.9	15	252.3BSN
<b>253</b> 2-in-1 Stick Down Ramp Edge/Cover Strip 0-12mm		Chrome	0.9	15	253.3C
		Brushed Steel	2.7	5	253.9C
		Nickel	0.9	15	253.3BSN
			2.7	5	253.9BSN

For prices contact your nearest distributor – see back cover

the **max** profile range

Premium heavy-duty metals mark out the **Max range** to bring complete peace of mind in domestic and commercial applications. Where strength and rigidity are key, make sure it's the Max – for profiles that will stand the test of time!

**Packing** - - Tube: 15 x 2.7m lengths = 40.5m Tube: 9 x 2.7m lengths = 24.3m

Product	Dimensions	Finish	Length (m)	Tube qty	Ref.
<b>214</b> Single Edge Raised Base - Super Max Duty		Polished Aluminium	2.7	15	214.9A
		Simbrass	2.7	15	214.9S
<b>223</b> Dual edge - Super Max Duty		Polished Aluminium	2.7	9	223.9A
		Simbrass	2.7	9	223.9S
<b>224</b> Dual edge Raised Base - Super Max Duty		Polished Aluminium	2.7	9	224.9A
		Simbrass	2.7	9	224.9S
<b>236</b> Extra Wide Cover Strip (universal)		Polished Aluminium	2.7	15	236.9A
		Simbrass	2.7	15	236.9S



Order your Floorwise Profiles brochure today.  
 Contact us on  
**0345 899 1000**

For prices contact your nearest distributor – see back cover



Floorwise provide a wide range of high-quality display stands, product samples and other support materials for all of our products.

These have all been professionally designed and produced to help the flooring professional demonstrate our products to their customers.

Please contact us on 0345 899 1000 to request any of our promotional display items and to discuss how we can help you upsell across the entire Floorwise range.

the **Classic** profile range

The **Classic Range** is precision-engineered to exacting standards. With more metal for your money, Floorwise premium quality profiles are durable, easier to handle, and finished to perfection.

Product	Dimensions	Finish	Length (m)	Tube qty	Ref.
<b>211</b> Single Edge		Polished aluminium	0.9	45	211.3A
		Polished aluminium	2.7	15	211.9A
		Simbrass	0.9	45	211.3S
		Simbrass	2.7	15	211.9S
<b>213</b> Single Edge Unpunched		Polished aluminium	2.7	15	213.9A
		Simbrass	2.7	15	213.9S
<b>220</b> Dual edge		Polished aluminium	0.9	45	220.3A
		Polished aluminium	2.7	15	220.9A
		Simbrass	0.9	45	220.3S
		Simbrass	2.7	15	220.9S
<b>230</b> Carpet cover strip 37mm		Polished aluminium	0.9	45	230.3A
		Polished aluminium	2.7	15	230.9A
		Simbrass	0.9	45	230.3S
<b>231</b> Cover Strip 25mm		Polished aluminium	0.9	45	230.3A
		Polished aluminium	2.7	15	230.9A
		Simbrass	0.9	45	230.3S
<b>232</b> Cover Strip 37mm		Polished aluminium	0.9	45	232.3A
		Polished aluminium	2.7	15	232.9A
		Simbrass	0.9	45	232.3S
		Simbrass	2.7	15	232.9S
<b>233</b> Lino Edge small 4mm		Polished aluminium	0.9	45	233.3A
		Polished aluminium	2.7	15	233.9A
		Simbrass	2.7	15	233.9S

For prices contact your nearest distributor – see back cover

**Packing** - Box: 45 x 0.9m lengths = 40.5m  
 Tube: 15 x 2.7m lengths = 40.5m

Other lengths may be available upon request

Product	Dimensions	Finish	Length (m)	Tube qty	Ref.
<b>234</b> Lino Edge medium 6mm		Polished aluminium	0.9	45	234.3A
		Polished aluminium	2.7	15	234.9A
		Simbrass	2.7	15	234.9S
		Simbrass	2.7	15	234.9S
<b>240</b> Square Edge Raised Base		Polished aluminium	2.7	15	240.9A
		Simbrass	2.7	15	240.9S
<b>241</b> Angle/Mat Edge 23mm		Polished aluminium	2.7	15	241.9A
		Simbrass	2.7	15	241.9S
<b>242</b> Stair/Matwell Edge 42mm		Polished aluminium	2.7	15	242.9A
		Simbrass	2.7	15	242.9S
<b>243</b> Carpet Tile Edge Unpunched		Polished aluminium	2.7	15	243.9A
		Simbrass	2.7	15	243.9S
<b>245</b> Z Edge, adjustable height up to 9mm		Polished Aluminium	0.9	45	245.3A
		Polished Aluminium	2.7	15	245.9A
		Simbrass	0.9	45	245.3S
		Simbrass	2.7	15	245.9S
<b>246</b> Z Edge, adjustable height up to 14mm		Polished Aluminium	2.7	15	246.9A
		Polished Aluminium	2.7	15	246.9A
		Simbrass	2.7	15	246.9S



# the Zenith profile range

The **Zenith Range** makes it easy to find the ideal match to Wood, Laminate & LVT flooring, delivering a neat, attractive and robust finish. The Stick Down range is a must for the professional fitter, cutting down installation time by up to 80% against slower drill and fix methods.

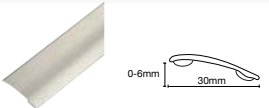
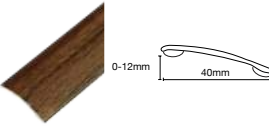
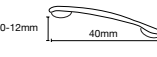
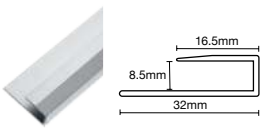
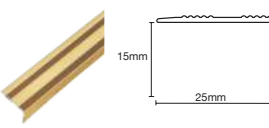
Product	Dimensions	Finish	Length (m)	Tube qty	Ref.
<b>251</b> Stick Down Ramp Edge/ Cover Strip 0-6mm 		Brushed Steel Nickel	2.7	5	251.9BSNA
		Chrome	2.7	5	251.9CA
		Oak	2.7	5	251.9OAA
		Dark Walnut	2.7	5	251.9DKWA
		Grey Oak	2.7	5	251.9GOA
<b>253</b> Stick Down Ramp Edge/ Cover Strip 0-12mm 		Brushed Steel Nickel	2.7	5	253.9BSNA
		Chrome	2.7	5	253.9CA
		Oak	2.7	5	253.9OAA
		Dark Walnut	2.7	5	253.9DKWA
		Grey Oak	2.7	5	253.9GOA
<b>277</b> Square Edge 8mm 		Matt Silver	2.7	10	277.9MS
		Matt Gold	2.7	10	277.9MG
<b>287</b> Stick Down Ramp Edge/ Cover Strip 0-6mm 		Matt Silver	2.7	10	287.9MSA
		Matt Gold	2.7	10	287.9MGA
		Oak	2.7	10	287.9OAA
		Dark Walnut	2.7	10	287.9DKWA
		Grey Oak	2.7	10	287.9GOA
<b>288</b> Stick Down Edge 15mm 		Matt Silver	2.7	10	288.9MSA
		Matt Gold	2.7	10	288.9MGA

For prices contact your nearest distributor – see back cover

**Packing** - Tube: 5 x 2.7m lengths = 13.5m (251 & 253)  
 Tube: 10 x 2.7m lengths = 27m (277 & 287)  
 Tube: 15 x 2.7m lengths = 40.5m (245 only)

Other lengths may be available upon request

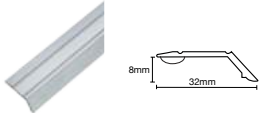
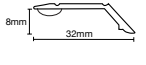
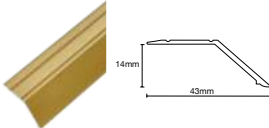
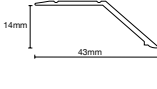
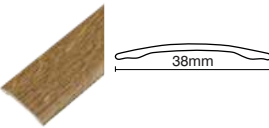
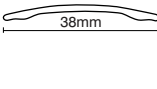
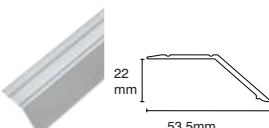
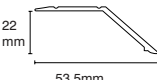
Product	Dimensions	Finish	Length (m)	Tube qty	Ref.
<b>289</b> Stick Down Sloping Edge 8mm 		Matt Silver	2.7	10	277.9MSA
		Matt Gold	2.7	10	277.9MGA
<b>290</b> Stick Down Sloping Edge 14mm 		Matt Silver	2.7	10	290.9MSA
		Matt Gold	2.7	10	290.9MGA
<b>291</b> Stick Down Cover Strip 38mm 		Matt Silver	2.7	10	291.9MSA
		Matt Gold	2.7	10	291.9MGA
		Oak	2.7	10	291.9OAA
		Dark Walnut	2.7	10	291.9DKWA
		Grey Oak	2.7	10	291.9GOA
<b>292</b> Stick Down Sloping Edge 22mm 		Matt Silver	2.7	10	292.9MSA
		Matt Silver	2.7	10	292.9MGA

For prices contact your nearest distributor – see back cover

# Flexible PVC floor profiles

## Curvable PVC Floor trims

A range of **Flexible PVC** transition profiles in a variety of colours that can be laid straight or easily curved on site.

Product	Dimensions	Finish	Length (m)	Tube qty	Ref.
<b>8775</b> Multiple height combination flat transition		see page 52-53	2.75	10	8775---
<b>8780</b> Multiple height combination ramped transition		see page 52-53	2.75	10	8780---
<b>8785</b> Multiple height combination ramped transition		see page 52-53	2.75	10	8785---
<b>8790</b> Multiple height combination ramped transition		see page 52-53	2.75	5	8790---
<b>87P1</b> Base channel 8.5mm		-	2.75	10	87P1
<b>87P2</b> Base channel 16mm		-	2.75	10	87P2
<b>87P3</b> Base channel 6mm		-	2.75	10	87P1
<b>87P4</b> Base channel 12mm		-	2.75	10	87P1
<b>87A2</b> Base channel 12mm		Punched Unpunched	2.75 2.75	10 10	87A2P 87A2U
<b>87A1</b> Base channel 6mm		-	2.75	10	87A1

### Colours

The product code for ordering Curvable PVC Floor Trims is made up of the relevant part number above (Ref.) and the 3-letter colour code shown on page on page 53. The code for an 8780 Curvable PVC Floor Trim in Royal Blue would therefore be 8780ROY.

## Floor level combinations

Combinations of tops and bases and the heights of floorcoverings they connect

	8775	8780	8785	8790
<b>87P2</b>	18 14-16	17-18 13-15	17-18 15-17	n/a 15-19
<b>87P4</b>	13-14 14-16	10-11 11-13	7-8 8-10	3-7
<b>87P1</b>	14 11-13	14-15 10-12	14-15 12-14	n/a 14-16
<b>87P3</b>	7-8 8-9	5-7 6-8	2-3 4-6	0-3
<b>87A1</b>	10 8-9	0-3 2-4	0 0-2	n/a n/a
<b>87A2</b>	8-9 6-7	0-1 2-4	n/a 0-1	n/a n/a
	8 5-7	8-9 6-8	8 n/a	0 n/a
	5 5-7	1-2 2-4	0 0-1	n/a n/a
	9-10 8-10	0-1 2-4	n/a 0-1	n/a n/a



For prices contact your nearest distributor – see back cover

# Stair Nosings, Skirtings and Trims

Aluminium Stair Nosings	45
Q-Range	46
Aluminium and PVC Stair Edge Trims and Angles	48
Floormitre Cap and Cove Systems	48
Flexible Bevels, Ramps, Profiles and Joints	49
PVC Skirtings	50
Nosings, Trims and Skirtings colour chart	52

Stairs are an inherently dangerous part of any building presenting both a trip and a fall hazard, so don't skimp when it comes to safety.

Floorwise offer a range of nosings with flat, raked or bullnose profiles to suit almost any stair application and floorcovering along with a selection of edge trims and angles to help you get the perfect finishing detail.

We also offer a wide range of colour options as well as a selection of standard tread or supergrip inserts to suit your specific application.



## Aluminium Stair Nosings

### Standard gauge

Standard gauge aluminium stair nosings best suited for floorcoverings with a thickness of 2mm–3.5mm.

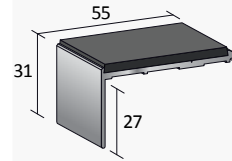

SF11 - single channel flat

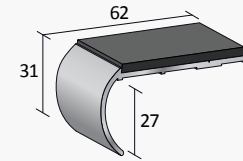

SF31 - single channel bullnose

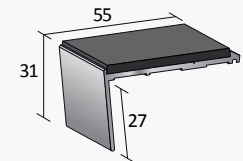

SF51 - single channel raked

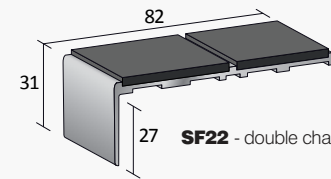

SF22 - double channel flat

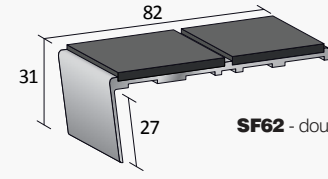

SF62 - double channel rake

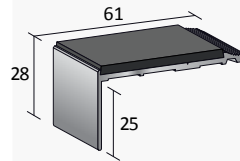

SF141 - single channel flat - ramp back

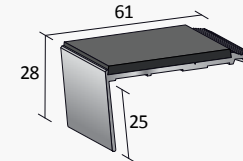

SF151 - single channel raked - ramp back

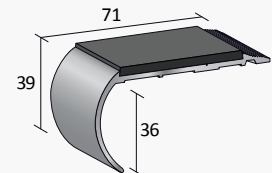

SF161 - single channel bullnose - ramp back

### Heavy duty gauge

Heavy duty gauge aluminium stair nosings best suited for floorcoverings with a thickness of 4mm–7mm.

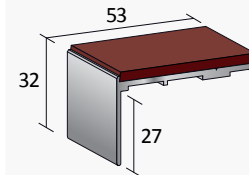

HF11 - single channel flat

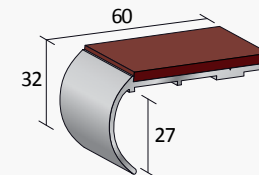

HF31 - single channel bullnose

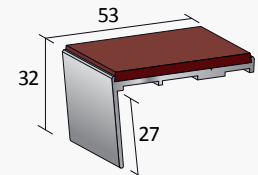

HF51 - single channel raked

- Stock lengths: 2.44m, 2.75m and 3.2m
- Pre-packed (secret fixing): 20 lengths x 1.22m
- Also available cut to size, drilled & undrilled

- Brightened Finish
- Super Chrome Finish

### Colours

The product code for ordering Stair Nosings is made up of the relevant part number above and the 3-letter colour code shown on page on page 52. The code for a SF11 Single Channel nosing in Poppy would therefore be SF11POP.

Drawings not to scale.

## Q-Range

### Slenderline gauge

Stair nosings best suited for floorcoverings with a thickness of 0mm–3.5mm

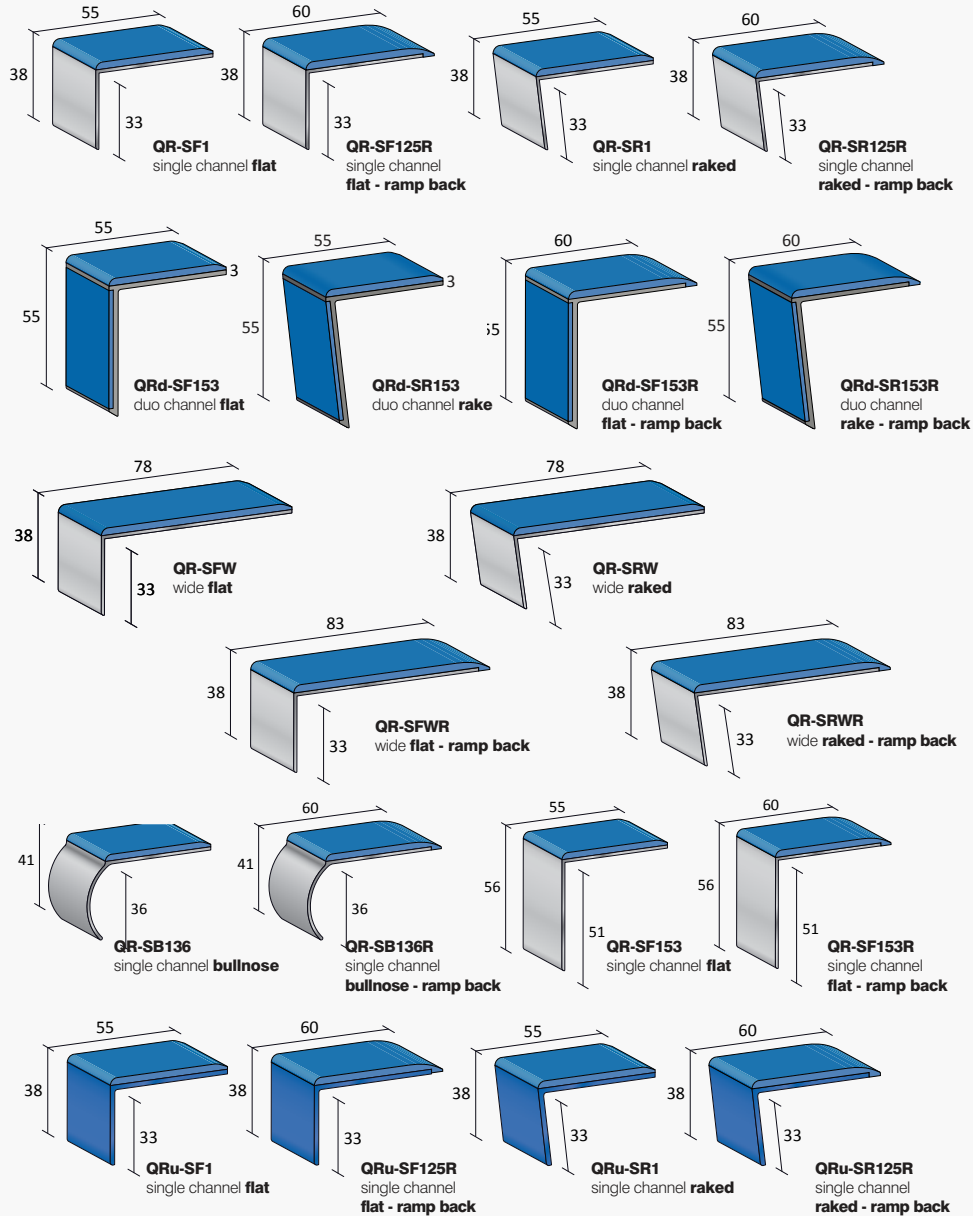

### Heavy duty gauge

Stair nosings best suited for floorcoverings with a thickness of 4-7mm

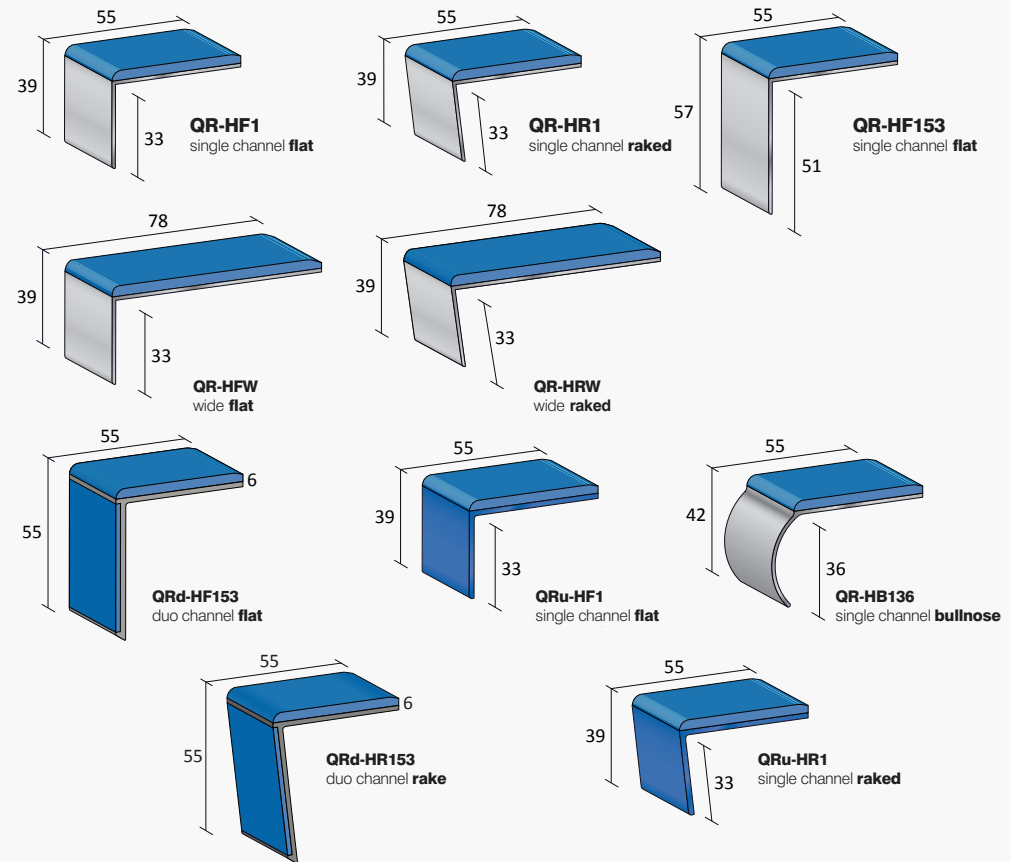

### Building regulations best practice

All Q-Range stair nosings (except bullnose) offer a Building Regulations best practice solution in PVCu or when specified with polar grey tread material.

NOTE: There should be 30 points of difference in the LRV value between the floor covering and the stair nosing.

- Stock lengths: 2.44m, 2.75m and 3.2m
- Pre-packed (secret fixing): 20 lengths x 1.22m
- Also available cut to size, drilled & undrilled

- Brightened Finish
- Super Chrome Finish

### Colours

The product code for ordering Stair Nosings is made up of the relevant part number above and the 3-letter colour code shown on page 52. The code for a QR-HF1 Single Channel nosing with Yellow Tread would therefore be QR-HF1YEL.

Drawings not to scale.



## Aluminium and PVC Stair Edge Trims and Angles

Pre-formed universal angles for finishing step sides on open string staircases. Special shapes, bespoke to project are available on request and subject to lead times.

**A610**  
Aluminium 83° pre-formed Angles

**A620**  
Aluminium 90° pre-formed Angles

**A600**  
Aluminium stock length 2.75m

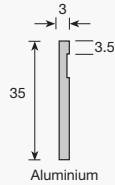

**P610**  
PVCu 83° pre-formed Angles

**P620**  
PVCu 90° pre-formed Angles

**P600**  
PVCu stock length 2.75m

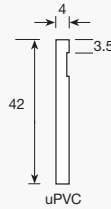

- **Universal tabs** are included with package to cover all heights.
- **Pre-formed:** 83° or 90°, 360mm x 360mm, singles or boxed in 20s.
- **Stock lengths:** 2.75m complete with joints and tabs to make up on site.

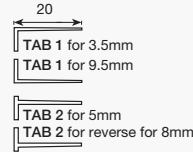

- Brightened Finish
- Super Chrome Finish

## Floormitre Cap and Cove System

### Internal and external floormitres

Designed to make the fitting of vinyl around corners easier, quicker and smoother.

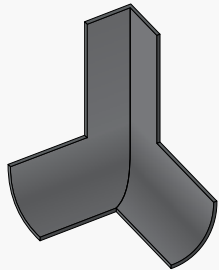

**CCFM1**  
Internal Floormitre  
50 per box

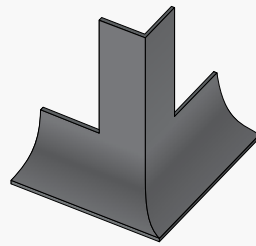

**CCFM2**  
External Floormitre  
50 per box

## Flexible Bevels, Ramps, Profiles and Joints

### Bevel strips and ramp edges

Flexible finishing strips and ramps for floorcovering edges. Can be easily curved on site.

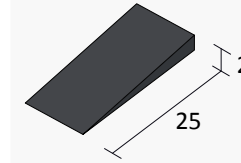

**8751**  
**25 x 2mm**

5m coils  
5 per box

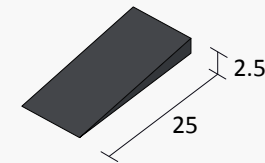

**8752**  
**25 x 2.5mm**

5m coils  
5 per box

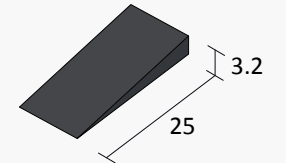

**8753**  
**25 x 3.2mm**

25m coils  
5 per box

**8754**  
**33 x 4.5mm**

2m lengths  
50 per box

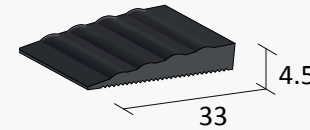

**8755**  
**38 x 6.0mm**

2m lengths  
50 per box

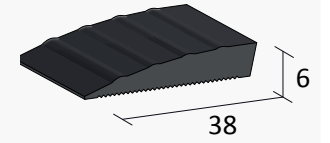

### Flexible flooring profiles

Finishing profiles for joints between floor coverings. Can be easily curved on site.

**8770 Dual Edge**  
**35 x 5mm/9mm**

2m lengths  
25 per box

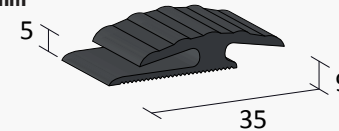

**8772 Ramp Edge**  
**40 x 5mm**

2m lengths  
25 per box

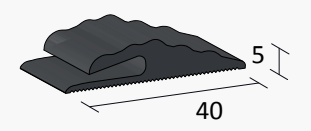

### Expansion joints

Finishing profiles for joints between floor coverings. Can be easily curved on site.

**QCJ50**  
**50 x 2.5mm**

15m coils  
3 per box

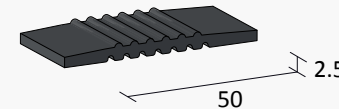

**QCJ75**  
**75 x 2.5mm**

15m coils  
2 per box

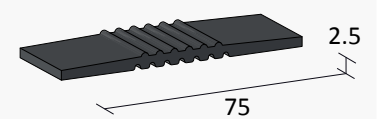

### Colours

The product code for ordering Flexible Bevels, Ramps, Profiles and Joints is made up of the relevant part number above and the 3-letter colour code shown on page on page 52. The code for a 8770 Dual Edge profile in Charcoal would therefore be 8770CHA.

Drawings not to scale.

## PVC Skirtings

### Sit-on skirting

Easy to fit standard skirting finish for vinyl floors.

- 8710**  
100mm  
2m lengths / 30 per box
- 8710C**  
100mm  
32m coil (curve on site)
- 8711**  
75mm  
2m lengths / 40 per box
- 8712**  
150mm  
2m lengths / 20 per box

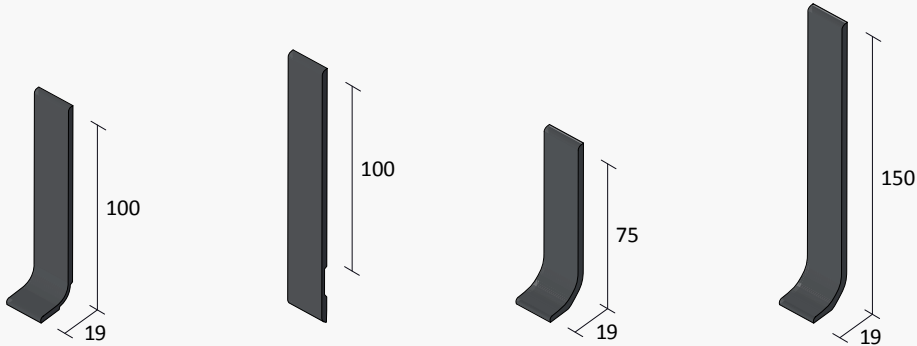

### Set-in skirting

Skirtings with welded foot for seamless and hygienic finish with vinyl floors in hospitals, schools and wet areas (e.g. bathrooms).

- 8720**  
**100 x 2.0mm**
- 8721**  
**100 x 2.5mm**
- 8722**  
**100 x 3.2mm**
- 8723**  
**150 x 2.0mm**
- 8724**  
**150 x 2.5mm**

2m lengths  
14 per box

2m lengths  
14 per box

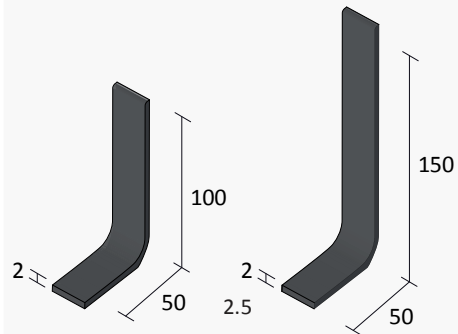

### Flat skirting

Protective edge to wall and door bases. Use with vinyl floors or carpet tiles.

- 8761**  
**100mm**  
32m coil
- 8762**  
**150mm**  
32m coil
- 8763**  
**300mm**  
16m coil

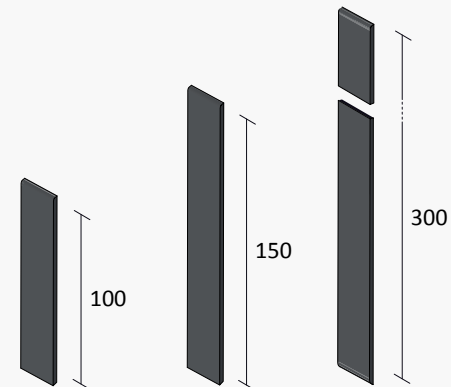

### Capping strips

Finishing caps for floor coverings when material is formed up the wall base.

- 8740**  
**40 x 4mm**  
2m lengths  
40 per box
- 8741**  
**45 x 4mm**  
2m lengths  
40 per box
- 8742**  
**40 x 6mm**  
2m lengths  
50 per box
- 8744**  
**38 x 4mm**  
25m coils only  
3 per box

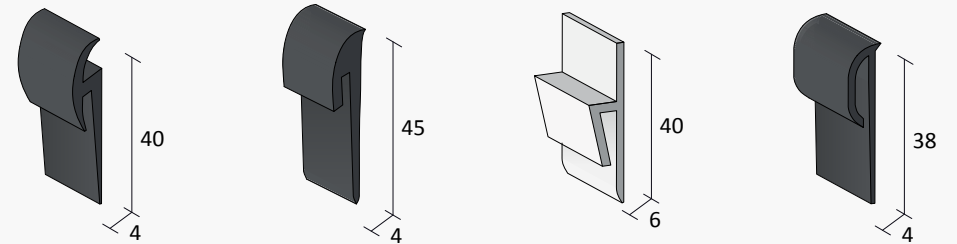

### Cove formers

Preformed cove support for vinyl or linoleum flooring to curve up the wall base from the floor edge.

- 8731**  
**20 x 20mm**  
2m lengths  
50 per box  
(Black only)
- 8730**  
**32 x 32mm**  
2m lengths  
40 per box  
(Black only)
- 8732**  
**35 x 35mm**  
2m lengths  
40 per box  
(Black only)

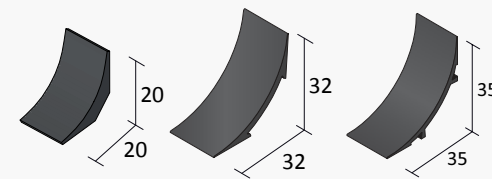

- 8733**  
**42 x 42mm**  
2m lengths  
20 per box  
(Black only)

2m lengths  
20 per box  
(Black only)

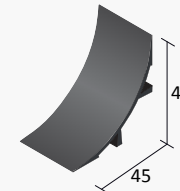

### Combined cove former and capping strip

This combined, preformed cove former and capping strip is a valuable time saver on site.

- 8743**  
**100 x 32mm**  
2m lengths / 20 per box

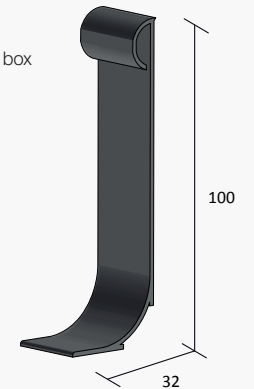

### Colours

The product code for ordering Capping Strips is made up of the relevant part number above and the 3-letter colour code shown on page on page 53. The code for a 8740 Capping Strip in Dark Brown would therefore be 8740DBR.

Drawings not to scale.

# Stair Nosings, Skirting and Trims Colour Chart

✓\* Minimum quantities may apply

Code	Colour	LRV	Stair Nosings			Stair Edge Trims and Angles	PVCu Skirting	Coves and Capping Strips	Bevels and Ramps	Curvable PVC Floor Trims
			Standard Tread	Super Grip (Not in Q-Range)	PVCu Channel					
CAR	Carbon	5		✓						
CLA	Claret	6	✓		✓	✓				✓*
BLK	Black	6	✓		✓	✓	✓	✓	✓	✓*
DBR	Dark Brown	9					✓	✓	✓*	
RUB	Ruby	9		✓						
RUS	Rustic	10	✓		✓	✓				✓*
PEA	Peat	10	✓		✓	✓				✓*
GRA	Granite	11	✓		✓	✓	✓			✓*
BLU	Dark Blue	11	✓		✓	✓				✓*
REG	Regency	11	✓		✓	✓	✓			✓*
SPR	Spruce	11	✓		✓	✓				✓*
POP	Poppy	13	✓							✓*
CHA	Charcoal	15					✓	✓	✓*	
FLI	Flint	15	✓		✓	✓				✓*
ROY	Royal Blue	16	✓							✓*
FAW	Fawn	21	✓							✓*
AQA	Aqua	22		✓						
BOU	Boulder	25					✓			
LIG	Light Grey	26	✓		✓	✓				✓*
PLA	Platinum	27		✓						
CLG	Cloud Grey	26					✓	✓	✓	
JAD	Jade	30	✓							✓*
CAR	Caramel	31					✓	✓		
TAN	Tangerine	33	✓							✓*
SAN	Sand	41		✓						
HOR	Hornet	47		✓						
PLR	Polar Grey	49	✓		✓	✓	✓			✓*
IVO	Ivory	51	✓		✓	✓	✓			✓*
SKY	Sky	52	✓							✓*
LIM	Lime	53	✓							✓*
SUN	Sun	56	✓							✓*
YEL	Yellow	67	✓		✓	✓				✓*
PHO	Photoluminescent	69	✓							
WHT	White	81	✓		✓	✓	✓	✓	✓*	✓*

# Tools and Sundries

<b>Cutting</b>	55
<b>Carpet Fitting</b>	56
<b>Measuring and Scribing</b>	59
<b>Surface Preparation</b>	60
<b>Wood and Laminate Floor Laying</b>	62
<b>PVC/Lino Laying</b>	63
<b>Workwear and Protection</b>	64
<b>Storage and Handling</b>	64

Choosing the right tools for the job has never been easier!

Floorwise sells a selection of the world's best tools for carpet installers. Our range has been carefully selected to provide the ultimate in functionality, practicality and long-lasting product quality. This means that we are confident that tools from the Floorwise range will provide the maximum assistance for professional floor fitters seeking a quality installation.





## Tools and Sundries

Product Type	FWG Ref	Description	Quantity	Colour
<b>Cutting tools Knives</b> 	F7510		1	Chrome
	F7510B		1	Blue
	F7510BK		1	Black
	F7510W	Dolphin Knife with Holster	1	White
	F7510G		1	Green
	F7510Y		1	Yellow
	F7510R		1	Red
	F7515	Professional Linoleum Tucking Knife	1	
F7514	Dolphin Knife 2000 with Holster	1	Chrome	
<b>Cutting tools Blades</b> 	F7544	Hooked + Pointed Blades	20 x 5 = 100	-
	F7546	Heavy Duty Blades	20 x 5 = 100	-
	F7547	Medium Duty Blades	20 x 5 = 100	-
	F7551B	Blades	12 Pack	-
	F7548	Hooked Blades	20 x 5 = 100	-
	F7549	Concave Blades	20 x 5 = 100	-
	F7545	Super Hooked Blades	20 x 5 = 100	-
	F7550B	Razor Style Blades	20 x 5 = 100	-
	F7554B	Slotted Blades	20 x 5 = 100	-
	F7214B	Scraper Blades	10 x 10 = 100	-
	F7216B	Scraper Blades	10 x 10 = 100	-
<b>Cutting tools Shears</b> 	F7520	12" Professional Knife Edge Shears	1	-
	F7521	10" Professional Knife Edge Shears	1	-
	F7524	7" Stainless Steel Napping Shears 2 finger	1	-
	F7524-7	Professional Napping Shears 3 Finger	1	-
	F7525	Super Gripper Shears	1	-
	F7525A	Spare Anvil	1	-
	F7525B	Spare Blade	1	-
	F7527	Mitre Shears	1	-
	F7527A	Spare Anvil	1	-
	F7527B	Spare Blade	1	-
	F7528	Aviation Snips	1	-

For prices contact your nearest distributor – see back cover



## Tools and Sundries

Product Type	FWG Ref	Description	Quantity	Colour
<b>Cutting tools</b> <b>Shears continued</b> 	F7550	Combi Carpet Trimmer	1	-
	F7550B	Razor Style Blades	100	-
	F7551	Crain Deluxe Carpet Trimmer	1	-
	F7551B	Crain Carpet Trimmer Blades	12	-
	F7552	Araseur Carpet & Vinyl Trimmer	1	-
	F7552B	Araseur Hooked Blades	20 x 5 = 100	-
	F7553	High Tech Cutter	1	-
	F7553B	High Tech Cutter - Hooked Blades	20 x 5 = 100	-
	F7560	Hacksaw	1	-
	F7560B	Hacksaw Blades	10	-
<b>Knee kickers</b> 	F7006	Roberts GT Knee Kicker	1	-
	F7002	Crain Deluxe Knee Kicker	1	-
	F7010	Crain Swivel Lock Power Stretcher	1	-
	F7010E	Crain Spare Tube	1	-
<b>Heat seaming irons</b> 	F7014	Roberts Deluxe Heatbond Carpet Seaming Iron	1	-
	F7015	F7015 110V Crain Grooved Deluxe Heat 1 Seaming Iron 110V	1	-
	F7015	F7015 110V Crain Grooved Deluxe Heat 1 Seaming Iron 220V	1	-
	F7015C	Carrying Case	1	-
	F7020	Straight Axle Seam Roller	1	-
	F7020F	Flexible Axle Seam Roller	1	-
	F7021W	7.5kg Seam Weight	1	-
	F7021	Carpet Seam Clamp	1	-

For prices contact your nearest distributor – see back cover

## Tools and Sundries



Product Type	FWG Ref	Description	Quantity	Colour
<b>Tack hammers</b> 	F7022	Magnetic Tack Hammer	1	-
	F7023	Super Tack Hammer	1	-
	F7024	Claw Hammer	1	-
	F7025A	Magnetic Driving Bar	1	-
	F7027	Stair Tool 3.5"	1	-
	F7028	Tack & Moulding Lifter	1	-
	F7029	Carpet Awl	1	-
	F7031	Bent Stair Tool 3.5"	1	-
	F7034	Speedcatt Tucking Tool	1	-
	F7035	Row Separator	1	-
<b>Nails</b>   	F7700	19mm Concrete Nails	500g	-
	F7701	25mm Concrete Nails	500g	-
	F7712	15mm Concrete Nails	500g	-
	F7713	32mm Concrete Nails	500g	-
	F7730	15mm Concrete Nails	1kg	-
	F7731	19mm Concrete Nails	1kg	-
	F7732	25mm Concrete Nails	1kg	-
	F7733	32mm Concrete Nails	1kg	-
	F7710	20mm Ring Shank Nails	500g	-
	F7711	25mm Ring Shank Nails	500g	-
	F7714	30mm Ring Shank Nails	500g	-
	F7720	20mm Ring Shank Nails	1kg	-
	F7721	25mm Ring Shank Nails	1kg	-
	F7722	30mm Ring Shank Nails	1kg	-
	F7770	25mm Zinc Plated Slotted Screws	500g	-
	F7770S	25mm Simbrass Slotted Screws	500g	-
	F7764	20mm Gimp Pins	500g	-
	F7045Y	5/5.5mm Yellow Rawl Plugs	1000	Yellow
	F7045R	5.5/6mm Red Rawl Plugs	1000	Red
	F7763	25mm Blued Tacks	500g	-
F7763A	25mm Blued Tacks	1kg	-	
F7768	16mm Cork Pins	500g	-	

## Tools and Sundries

Product Type	FWG Ref	Description	Quantity	Colour
 <b>Masonry drill bits</b>	F7040	4mm Masonry Drill Bit	10	
	F7041	5mm Masonry Drill Bit	10	
	F7042	5.5mm Masonry Drill Bit	10	
	F7043	5mm SDS Masonry Drill Bit	10	
	F7044	5.5mm SDS Masonry Drill Bit	10	
 <b>Stapling guns and staples</b>	F7049	Tacwise 191ELS Combination Stapler & Nailer Tool	1	-
	F7050	Maestri ME4000 Stapling Machine	1	-
	F7050/16	16mm Bronzed Staples for Hardboard	10,000	-
	F7050/20	20mm Bronzed Staples for Plywood	10,000	-
	F7051	Maestri ME606 Electronic Staple & Brad Machine	1	-
	F7051/18	18mm Silver Staples for ME606	4,800	-
	F7051/22	22mm Silver Staples for ME606	4,800	-
	F7051/TG15	15mm Brad/Pins	8,000	-
	F7051/TG19	19mm Brad/Pins	7,000	-
	F7051/TG25	25mm Brad/Pins	5,000	-
	F7061	Hammer Tacker	1	-
	F7064	Staple Remover	1	-
	F7063	Rapid Staple Gun	1	-
	F7063/10	10mm Rapid Staples	5,000	-
	F7063/14	14mm Rapid Staples	5,000	-
	F7065	Tacwise A54 Heavy Duty Hammer Tacker	1	-
	F7061/8	8mm Staples	5,000	-
F7061/9	9mm Staples	5,000	-	
F7061/10	10mm Staples	5,000	-	

For prices contact your nearest distributor – see back cover



## Tools and Sundries

Product Type	FWG Ref	Description	Quantity	Colour
 <b>Hot melt guns</b>	F7894	Heavy Duty Industrial Hot Melt Adhesive Gun	1	-
	F7891/12	Industrial Hot Melt Adhesive Gun	1	-
	F7882	Carrying Case for All Guns	1	-
	F7893/12	Cordless Industrial Hot Melt Adhesive Gun	1	-
	F7890	Badaptor	1	-
	F7990H	Tackfix 180 Glue Sticks for Hardwood	20	-
	F7990C	Tackfix 48 Glue Sticks for Concrete	20	-
	F560	43mm Hot Melt Glue Slugs	85	-
	F565	12mm Hot Melt Glue Sticks	160	-
 <b>Measuring and scribing equipment</b>	F7300	Chalk Line Reel	1	-
	F7301	Chalk Line Refill	8oz	White
	F7302	Chalk Line Refill	8oz	Blue
	F7303	Chalk Line Refill	8oz	Red
	F7335	5m Measuring Tape	1	-
	F7338	8m Measuring Tape	1	-
	F7340	Metre Measuring Stick	1	-
	F7350	Leica Laser Measure with Bluetooth	1	-
	F7120	Bar Scriber	1	-
	F7120P	Spare Pins	1	-
	F7121	Recess Scriber	1	-
F7121P	Spare Pins	1	-	



Order your Floorwise Tools brochure today.  
Contact us on **0345 899 1000**



## Tools and Sundries

Product Type	FWG Ref	Description	Quantity	Colour	
<b>Straight edges and scribes</b> 	F7304	2m Flexible Straight Edge	1	-	
	F7305	4m Flexible Straight Edge	1	-	
	F7306	Adjustable Straight Edge	1	-	
	F7307	2m Non-Slip Flexible Straight Edge	1	-	
	F7308	4m Non-Slip Flexible Straight Edge	1	-	
	F7535	Invisiseamer	1	-	
	F7535D	6' Extension	1	-	
	F7535E	12' Extension	1	-	
	F7122	Parajito Combination Scriber & Cutter	1	-	
	F7122P	Spare Pins	25	-	
	F7122B	Spare Blades	5	-	
	F7123	Parajito Scriber	1	-	
	F7123P	Spare Pins	25	-	
	F7124	8" Dividers	1	-	
	F7516	Crain Nickel Plated Mitre Box	1	-	
	<b>Strippers and Scrapers</b> 	F7210/110	Power Stripper 110V	1	-
		F7210/240	Power Stripper 240v	1	-
		F7210B	60mm Spare Blade	1	-
F7210LB		130mm Spare Blade	1	-	
F7210TW		Transport Wheels	1	-	
F7210T		T-Handle	1	-	
F7210C		Carrying Case	1	-	
F7214/18		18" Deluxe Hand Scraper	1	-	
F7214/12		12" Deluxe Hand Scraper	1	-	
F7214B		Scraper Blades	10x10= 100	-	
F7219		Carpet Claw	1	-	
F7216/18		Crain Steel Handled Scraper	1	-	
F7216B		Scraper Blades	10x10= 100	-	
F7213		Hit Scraper	1	-	
F7213B		Reversible Spare Blade	1	-	
F7218		Parajito Long-Handled Scraper	1	-	
F7218B		Spare Blade	1	-	

## Tools and Sundries

Product Type	FWG Ref	Description	Quantity	Colour
<b>Mixers and rollers</b> 	F7222/110	Vitrex 850w Mixing Drill – 110V	1	-
	F7222/230	Vitrex 850w Mixing Drill – 230V	1	-
	F7225	Mixing Drill Whisk	1	-
	F7230/50	50cm Spiked Aeration Roller	1	-
	F7230/25	25cm Spiked Aeration Roller	1	-
	F7223/14	14l Gorilla Mixing Tub	1	-
	F7223/26	26l Gorilla Mixing Tub	1	-
	F7223/42	42l Gorilla Mixing Tub	1	-
	F7226	Mixing Drill Whisk	1	-
	F7225P	Parajito Drill Whisk	1	-
	F7230T	Telescopic Extension Pole	1	-
	F7238	12" Double Arm Frame for Primer Roller	1	-
	F7238R	12" Primer Roller	1	-
	F7221	Professional Stirring Station	1	-
<b>Trowels</b> 	F7227	Flemish Pointed Screeding Trowel 45x11cm	1	-
	F7228	Ragni Screeding Trowel 36x12cm	1	-
	F7229	Ragni Screeding Trowel 28x12cm	1	-
	F7257	3-piece Japanese Trowel Set	1	-
	F7240	Adhesive Trowel Pack 1mm x 4mm	1	-
	F7240B	Spare Blade 1mm x 4mm	1	-
	F7241	Adhesive Trowel Pack 1.5 x 5mm	1	-
	F7241B	Spare Blade 1.5 x 5mm	1	-
	F7242	Adhesive Trowel Pack 2mm x 6mm	1	-
	F7242B	Spare Blade 2mm x 6mm	1	-
	F7245-A1	18cm Adhesive Spreader – A1	1	-
	F7245-A2	18cm Adhesive Spreader – A2	1	-
	F7245-B1	18cm Adhesive Spreader – B1	1	-
	F7246-A1	25cm Adhesive Spreader – A1	1	-
	F7246-A2	25cm Adhesive Spreader – A2	1	-
	F7246-B2	25cm Adhesive Spreader – B1	1	-
	F7239	Shoe In Spiked Soles 3 size options M (7-9) L(9-11), XL (11-12)	1	-
F7237	Spiked Shoes	1	-	

## Tools and Sundries

Product Type	FWG Ref	Description	Quantity	Colour
<b>Applicators</b> 	F7030	Cartridge Applicator Skeleton Gun	1	-
	F7032	Combination Sausage Gun	1	-
	F7234	Carborundum Grinding Stone	1	-
	F7250	Disposable Adhesive Syringes & Needles	1	-
	F7236	24" Screed Leveller	1	-
	F7251	Premium Gun for Spray Canisters	1	-
<b>Wood and laminate floor laying equipment</b> 	F7461	Straticut Laminate Guillotine	1	-
	F7415	Ratchet Straps & Clamps	1	-
	F7404	Power Shunter	1	-
	F7405	Professional Tapping Block – Flat	1	-
	F7406	55cm Professional Pulling/Impact Iron	1	-
	F7407	Rubber Mallet	1	-
	F7410	Crain Undercut Saw	1	-
	F7433/110	Professional Door Trimmer 110v	1	-
	F7433B	Spare TCT Blade	1	-
	F7052	Maestri Veneer Pinner	6100 (box)	-
	F7052/TG15	15mm brads/pins	6100 (box)	-
	F7052/TG20	20mm brads/pins	6100 (box)	-
	F7052/TG25	25mm brads/pins	6100 (box)	-
	F7052/TG30	30mm brads/pins	6100 (box)	-



For prices contact your nearest distributor – see back cover

## Tools and Sundries

Product Type	FWG Ref	Description	Quantity	Colour
<b>PVC/Lino laying equipment</b>  	F7100/120	Grooving Machine – 120v	1	-
	F7100/230	Grooving Machine – 230v	1	-
	F7100B	130mm Grooving Blade	1	-
	F7100DB	130mm Diamond Grooving Blade	1	-
	F7153	Lino & PVC Strip Cutter	1	-
	F7154	LVT Hole Cutter	1	-
	F7155	Leister 'Groovy' Groover Tool	1	-
	F7101	LVT Design Cutter	1	-
	F7101B	Spare Blade	1	-
	F7105/110	Leister Triac ST Hot Air Welder – 110v	1	-
	F7105/220	Leister Triac ST Hot Air Welder – 220v	1	-
	F7106/110	Leister Triac ST Hot Air Welding Kit – 110v	1	-
	F7106/220	Leister Triac ST Hot Air Welding Kit – 220v	1	-
	F7108	Leister Standard Nozzle	1	-
	F7108S	Leister Speedweld Nozzle	1	-
	F7113	Router Handle	1	-
	F7113B	Router Blades	8	-
	F7150	PVC Edge Trimmer	6	-
	F7150B	Spare Blades	6	-
	F7152	Linocutter/Scriber	1	-
	F7136	Crain Steel Hand Roller	1	-
F7157	Pressing Hammer	1	-	
F7141/28	28kg Lino Roller	1	-	
F7141/50	50kg Lino Roller	1	-	
F7151	Mozart Trimmer	1	-	
F7151B	Spare Blades	5	-	
F7151P	Leather Pouch	1	-	
F7110	P Type Grooving Tool	1	-	
F7110B	U Shape Grooving Blades	10	-	
F7130	Spatula Trimming Knife	1	-	
F7130G	Spatula Guide	1	-	
F7130P	Leather Pouch	1	-	



## Tools and Sundries

Product Type	FWG Ref	Description	Quantity	Colour
<b>Workwear and protection</b> 	F7800	Snickers Floorlaying Master Trousers	1	-
	F7810	Flexiwork Floorlayers Trousers	1	-
	F7856	Snickers Hoodie	1	-
	F7860	Snickers 37.5 Short Sleeve Polo Shirt	1	-
	F7865	Toe Guard Jumper Boots	1	-
	F7870	Snickers Beaded Knee Pads	1 (Pair)	-
	F7817	Fento 200 Pro Knee Protectors	1 (Pair)	-
	F7818	Medical Knee Pads	1 (Pair)	-
	F7805	Snickers D30 Craftsman Knee Pads	1 (Pair)	-
	F7815	Leather Knee Pads	1 (Pair)	-
	F7819	Super Soft Knee Pads	1 (Pair)	-
	F7819L	Super Soft Knee Pads - Leather	1 (Pair)	-
	<b>Storage and handling</b> 	F7960	24" Floorlayers Toolbag	1
F7955		30" Rope Handled Canvas Tool Bag	1	-
F7950		24" Rolling Tool Box	1	-
F7900		Carpet Trolley with Pneumatic Tyres	1	-
F7905		Transport & Unroll Barrow	1	-
F7956		Strong Wheeled Canvas Trolley	1	-

For prices contact your nearest distributor – see back cover

# Entrance Matting

Entrance Matting ranges

66

Floorwise offer a carefully curated range of entrance matting options to suit most applications.

Our range has been defined around a selection of colourways which offer exceptional aesthetics, durability and value for almost any commercial matting application.

Please contact us for further details and product samples.



## Entrance Matting

### Endurance

11mm



#### SPECIFICATION

Gel latex backed contract grade ribbed matting.

<b>Pile weight</b>	1600g/m <sup>2</sup>
<b>Total weight</b>	2620kg/m <sup>2</sup>
<b>Pile composition</b>	100% PP 20% PES
<b>Total height</b>	11.0mm
<b>Backing</b>	Gel

#### COLOURS

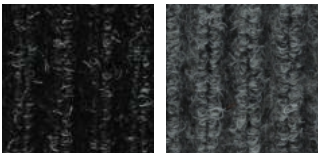

Anthracite Grey



Light Blue Light Brown

### Fortitude

9.8mm



#### SPECIFICATION

Gel latex backed contract grade zig-zag matting.

<b>Pile weight</b>	1150g/m <sup>2</sup>
<b>Total weight</b>	2130kg/m <sup>2</sup>
<b>Pile composition</b>	100% PP
<b>Total height</b>	9.8mm
<b>Backing</b>	Gel

#### COLOURS



Anthracite Grey Grey

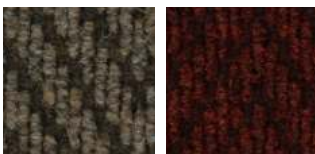

Brown Red

### Manhattan

7.5mm



#### SPECIFICATION

Secondary entrance matting.

<b>Pile weight</b>	830g/m <sup>2</sup>
<b>Total weight</b>	3450kg/m <sup>2</sup>
<b>Pile composition</b>	100% Nylon PA6
<b>Total height</b>	7.5mm
<b>Backing</b>	PVC

#### COLOURS



Apollo Central Park



Chrysler Empire State

For prices contact your nearest distributor – see back cover

## Entrance Matting

### Viking

7.8mm



#### SPECIFICATION

Contract grade matting.

<b>Pile weight</b>	650g/m <sup>2</sup>
<b>Total weight</b>	2740kg/m <sup>2</sup>
<b>Pile composition</b>	100% Nylon PA6
<b>Total height</b>	7.8mm
<b>Backing</b>	PVC

#### COLOURS

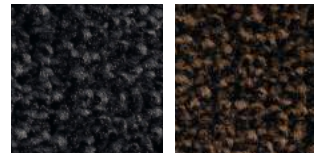

Anthracite Dark Brown



Oak Brown Steel Grey

For prices contact your nearest distributor – see back cover

FLS0001 E485  
 CR/SFB (43) 7  
 February 2022

# matting portfolio

wiseup@  
 www.floorwise.co.uk

Call **0345 899 1000** for a copy of our Entrance Matting sample folder.



# Tapes

Heatseam tape	68
Adhesive tape	69

Floorwise supply the flooring professional with a versatile range of tapes which won't let you down on the job.

From the plasticiser migration resistant double-sided vinyl tape to the low temperature heat seaming carpet tape, Floorwise will meet all your requirements.

Floorwise won't let you down when it comes to product quality, availability or supply.



## Tapes

Product Type	Code	Product	Roll Size	Quantity
			W (mm) x L (m)	Per box
Heatseam Tape	F301	Supreme	90mm x 25m	8
	F331	Supreme Low Temperature	90mm x 25m	8
	F351	Standard	90mm x 25m	8
	F391	Supreme Gold Heatseam Tape	90mm x 20m	10
Adhesive Tape	F365	Ultra heavy duty double sided cloth tape	50mm x 50m	24
	F366	PMR heavy duty cloth tape	50mm x 50m	24
	F367	Supreme heavy duty cloth tape	50mm x 50m	24
	F368	Waterproof single sided cloth tape	50mm x 50m	24
	F377	Supertac contact tape	25mm x 50m	24
	F377	Supertac contact tape	50mm x 50m	12
	F377	Supertac contact tape	85mm x 50m	8



For prices contact your nearest distributor – see back cover

# Artificial grass

Artificial grass 70

Accessories 71

**The all new Floorwise artificial grass range is softer and denser offering not just better value, but a better product**

The Floorwise range is the Gold Star standard when it comes to comfort, luxury and durability. Transform your garden, patio, terrace or holiday home with our stunning range. Enjoy the benefits of a beautiful looking lawn with no more weeding and mowing, and welcome in your Floorwise Artificial Grass, perfect for all environments, providing a luxurious feel underfoot.

Our 6 different types present the opportunity to select from 20mm, 25mm, 30mm, 35mm, 38mm and 40mm thickness.

Each offering a natural look to bring your outdoor area to life, all year round. Ordering could not be simpler - place your order with your retail unit and have it delivered to your door.



**10-Year Guarantee**

## Key Benefits

- Easy to install
- Low maintenance
- No watering
- Child friendly
- Pet friendly
- No more mud
- High UV stabilisation
- Cut to size/easily shaped
- 10-Year Guarantee

## Range of uses

- Gardens - front and back
- Patios
- Swimming pool surrounding areas
- Play areas
- Pet soiling areas
- Holiday homes

Products come in either 2m or 4m widths, and can be cut to the full or half lineal metre.

floorwise

## Artificial Grass and Accessories

Product	Suitability	Pile	Colour	Length	Guarantee
		Height	Tone		
<b>Peaks</b>	Gardens Balconies Play areas Indoor areas Pet soiling areas	20mm	3	2m	7
				4m	7
<b>Exmoor</b>	Gardens Balconies Pool surrounds Play areas Pet soiling areas	25mm	3	2m	10
				4m	10
<b>Brecon</b>	Gardens Patios Balconies BBQ areas	30mm	3	2m	10
				4m	10
<b>Northumberland</b>	Gardens Balconies Patios Landscaping	35mm	3	2m	10
				4m	10
<b>Snowdonia</b>	Gardens Balconies Patios Landscaping	38mm	3	2m	10
				4m	10
<b>Trossachs</b>	Gardens Balconies Patios Landscaping	40mm	3	2m	10
				4m	10

Product	Ref	Certified	Quantity
<b>U Shape Pins</b>	00	BS 4790 BS 7044 EN 117	10
<b>Aqua bond adhesive</b>	00	BS 4790 BS 7044 EN 117	10
<b>Weed Barrier</b>	00	BS 4790 BS 7044 EN 117	10
<b>Joining tape</b>	00	BS 4790 BS 7044 EN 117	10



# wise up to floorwise

## quality & value guaranteed



## national distributor network

**1 Neil Smith Ltd**  
Glasgow, G4 0TX  
Tel: 0141 552 1141  
sales@neilsmithltd.co.uk

**2 Provincial Floorcoverings Ltd**  
Belfast, BT15 3GU  
Tel: 028 9075 3202  
Fax: 028 9075 3901  
salesbelfast@pfil.ie

**3 Provincial Floorcoverings Ltd**  
Dublin, D12 E540  
Tel: 00353 (0) 1 626 3913  
Fax: 00353 (0) 1 460 4669  
salesdublin@pfil.ie

**4 Provincial Floorcoverings Ltd**  
Limerick, V94 W863  
Tel: 00353 (0) 61 227 100  
Fax: 00353 (0) 61 227 000  
sales@pfil.ie

**5 Lakes Flooring Supplies**  
Kendal, LA9 5RR  
Tel: 01539 726500  
sales@pucflooring.co.uk

**6 Preston Underlay Centre Ltd**  
Preston, PR1 1PN  
Tel: 01772 556345  
sales@pucflooring.co.uk

**7 Birch Distribution**  
Leeds, LS10 1AG  
Tel: 0113 244 4363  
Fax: 0113 244 8665  
l.sales@birchdistribution.co.uk

**8 Birch Distribution**  
Hull, HU7 0XD  
Tel: 01482 826654  
Fax: 01482 878693  
h.sales@birchdistribution.co.uk

**9 Hathaway Flooring**  
Manchester, M17 1EB  
Tel: 0161 872 8003  
sales@hathawayflooring.com

**10 Cornerstone Flooring**  
Doncaster, DN3 3FE  
Tel: 01302 835117  
Fax: 01302 302542  
cornerstonefloor@btconnect.com

**11 Birch Distribution**  
Sheffield, S9 5PH  
Tel: 0114 243 1230  
Fax: 0114 243 5118  
s.sales@birchdistribution.co.uk

**12 Woodall Brothers Ltd**  
Shrewsbury, SY1 3JE  
Tel: 01743 441584  
Fax: 01743 441629  
sales@woodallbrothers.co.uk

**13 Floorwise D & J Ltd**  
Southam, CV47 0DR  
Tel: 01926 814922  
Fax: 01926 817899  
sales@fdj.co.uk

**14 Floorwise Wales**  
Merthyr Tydfil, CF48 4TQ  
Tel: 01685 374243  
sales@floorwise-wales.com

**15 BL Flooring Supplies Ltd**  
Gloucester, GL2 5HY  
Tel: 01452 223355  
Fax: 01452 371284  
info@blflooring.co.uk

**16 BL Flooring Supplies Ltd**  
Bristol, BS2 9SH  
Tel: 0117 955 5454  
Fax: 0117 955 2626  
info@blflooring.co.uk

**17 Salesmark West Ltd**  
Amesbury, SP4 7LN  
Tel: 01980 880933  
mail@salesmark-west.co.uk

**18 Salesmark**  
Lancing, BN15 8UN  
Tel: 01903 750522  
Fax: 01903 851111  
sales@salesmark-floorwise.co.uk

**19 Fitwell Flooring Ltd**  
Newton Abbot, TQ12 6TR  
Tel: 01626 835935  
sales@fitwell.co.uk

**20 Fitwell Flooring Ltd**  
Redruth, TR15 1SS  
Tel: 01209 214344  
sales@fitwell.co.uk

**21 STS Flooring Distributors Ltd**  
Cambridge, CB23 8UD  
Tel: 0345 899 1000  
sales@stsflooring.co.uk

**22 STS Flooring Distributors Ltd**  
Hemel Hempstead, HP2 7ER  
Tel: 0345 899 1000  
sales@stsflooring.co.uk

**23 STS Flooring Distributors Ltd**  
Basildon, Essex, SS14 3DW  
Tel: 0345 899 1000  
sales@stsflooring.co.uk

**24 STS Flooring Distributors Ltd**  
Croydon, Surrey, CR0 4WP  
Tel: 0345 899 1000  
sales@stsflooring.co.uk

**25 STS Flooring Distributors Ltd**  
Orpington, Kent, BR5 3SS  
Tel: 0345 899 1000  
sales@stsflooring.co.uk

### headoffice:

**Floorwise Group Ltd.**  
Floorwise House, 22 High Street  
Kegworth, Derby, DE74 2DA, UK  
Tel: +44 (0)1509 673974  
Fax: +44 (0)1509 674841

